

**Kingdom of Cambodia**  
**Nation Religion King**



**Ministry of Health**  
**Medical Equipment Maintenance**  
**Guidebook**  
**Part A**

**General Knowledge and Technical Information**

Prepared by:

- Hospital Services Department
- National Maternal and Child Health Center
- JICA MEDEM Project



Japan International Cooperation Agency

**December 2008**

**Edition: 5**

Unofficial Translation from Khmer Version

# CONTENT

Preface

Abbreviation

Definition of term in this Guidebook

1. Introduction .....	1
2. Role of Medical Equipment (ME) Maintenance Technician .....	3
3. ME Service Request Flow .....	7
4. Preventive Maintenance.....	12
5. Spare Parts Management.....	18
6. Role of Operator About Medical Equipment.....	25
7. Basic Clinical Engineering .....	39
8. Evaluation of Usability for the ME .....	54
9. Lesson Learned on ME maintenance from National Maternal and Child Health Centre .....	63
10. Basic Computer Operation.....	73
11. Introduction Manual of MEDEM Inventory Software Program.....	82
12. Basic Theory of Electricity.....	88
13. Electrical Testing Instruments.....	96
14. Cleaning Management .....	105
15. Infection Control .....	112

## PREFACE

“Guidebook of Medical Equipment Maintenance” is a tremendous result of MEDEM Project working group of the Ministry of Health. Key health development partners, especially JICA were actively involved in the development of this useful Guidebook. The main purpose of this book is to provide the Medical Equipment Maintenance technical skill based on the current resource of health facilities in order to ensure proper Medical Equipment Management and to improve the quality of medical service delivery.

I hope that “the Guidebook of Medical Equipment Maintenance” will become a useful reference for leaders and working groups of all target hospitals as well as development partners and used to strengthen and improve the activities of current and future Medical Equipment Management and Maintenance in public hospitals.

On behalf of the Ministry of Health, I would like to express my deeply thanks to all members of MEDEM Project, especially JICA for the contribution of technical and financial support to develop this Guidebook of Medical Equipment Maintenance.

I privileges to disseminate the use of document officially in the purpose of promotion of medical equipment management and maintenance in public hospitals in order to contribute the improvement of medical services quality and reduce poverty for the citizen.

Phnom Penh, December 16, 2008

**For Minister  
Secretary of State for Health**

**Prof. Eng Hout**



## Abbreviations and Acronyms

ME	Medical Equipment
MoH	Ministry of Health
JICA	Japan International Cooperation Agency
MEDEM	Promotion of Medical Equipment Management System
HSD	Hospital Services Department
NMCHC	National Maternal and Child Health Center
CPA	Complimentary Package of Activities
OD	Operational District
PHD	Provincial Health Department
RH	Referral Hospital
PCB	Printed Circuit Board
WHO	World Health Organization
ICF	Intracellular Fluid
ECF	Extra Cellular Fluid
RBF	Renal Blood Flow
RPF	Renal Plasma Flow
GFR	Glomerular Filtration Rate
RBC	Red Blood Cells
WBC	White Blood Cells
FTA	Fault Tree Analysis
FMEA	Failure Mode Effect Analysis
MTBF	Mean Time Between Failures
MTTR	Mean Time To Repair
OS	Operating systems
MEDEMIS	MEDEM Inventory Software
NH	National Hospital
OT	Operating Theatre
OPD	Out Patient Department
USA	United State of America
UNFPA	United Nations Population Fund
UNICEF	United Nations Children Fund
DCV	Voltage of Direct Current
AVC	Voltage of Alternative Current



# DEFINITION OF TERMS

## Part 1: About Software and Activity

### **MEDEM Inventory Software (MEDEMIS):**

The database inventory software is used to record useful information of individual medical equipment for its management and maintenance at target hospitals, designed by MEDEM Project.

### **Medical Equipment Management**

Includes administrative management, preventive maintenance and repair activity.

### **Maintenance**

An activity for keeping the medical equipment in good condition.

### **Preventive Maintenance**

An activity for preventing the medical equipment from prospective failure.

### **Routine Maintenance**

It includes visual inspection functional inspections. It is carried out by operator and maintenance staff.

### **Regular Maintenance**

It is regular maintenance carried out by staff of Medical Engineering Unit (technical staff), depending on group of equipment. It includes visual inspection, functional inspection, performance inspection and electrical safety testing.

### **Repair**

An activity for mending to inherent function.

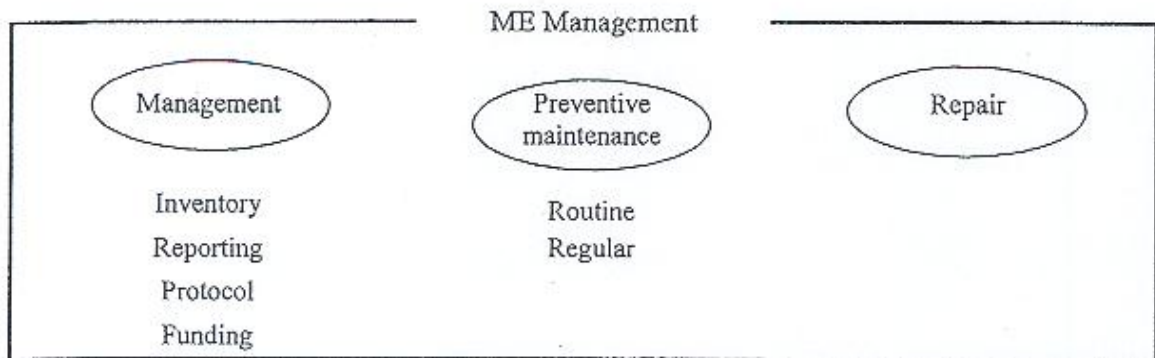

### Maintenance Check Sheet

The sheet listed the order of steps and items to be checked during maintenance activity.

## Part 2: Methods and Time

### Visual Inspection

The inspection carried out by naked eyes and/or hands to confirm the physical injury and ruggedness of the equipment without operation e.g. cracked enclosure-operation panel, loosed knob, abnormal smell-sound, etc.

### Functional Inspection

Inspection deals with handling and functioning of equipment e.g. function switches, display, indicating lamp, etc.

### Performance Inspection

Inspection deals with the performance (reliability) or safety of equipment. For example, input/output characteristic, stability, sensitivity, etc. Staff of National Workshop could do for some equipment.

Inspection category/ Implementer	Visual inspection	Functional inspection	Performance inspection
Equipment operator	<input checked="" type="checkbox"/>	<input checked="" type="checkbox"/>	
Maintenance staff	<input checked="" type="checkbox"/>	<input checked="" type="checkbox"/>	<input checked="" type="checkbox"/>

### Part 3 : Name of Objects

#### Hospital Facility

The all object for operating the hospital, for example building, generator, furniture and medical equipment.

#### Medical Equipment

A machine used for providing medical service. Usually it needs some external source for operation such electricity, water, and pressure. Almost of this require maintenance activity. It is object of MEDEMIS.

#### Instrument

A tool or device used for a medical task, for example forceps, scissors. Usually it is simple structure and doesn't require complicated maintenance activity. It is not object of MEDEMIS.

#### Medical Furniture

A furniture for medical purpose such a bed, instrument cabinet, etc. It is not object of MEDEMIS.

#### Medical Facility

A fixed object or machine for supporting medical equipment or medical service, for example incinerator, medical gas supply system, water treatment plant, etc.

#### Infrastructure

The basic services that are necessary for operation of medical equipment, for example electric power supply, water and gas.

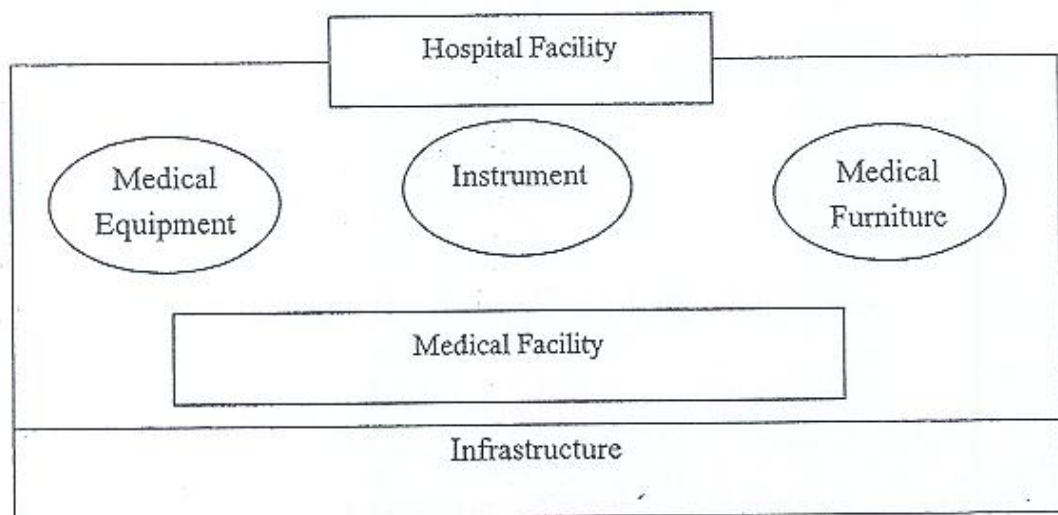



**Component**

Combination of parts and has a specific function, which several of them assemble the main body. Medical equipment usually consisted of electrical component, mechanical component, electronic component, etc.

**Consumable**

Unformed objects that deteriorate or lose their proper function with frequency of consumption or passage of time, e.g. filter, oil, etc.

**Accessory**

Part connected from the main body in order to complete total function/performance of the equipment e.g. patient electrodes for ECG equipment, Patient circuit for Anesthesia Apparatus, etc.

**Moving parts**

The part moving during runs or operates the equipment carbon brush for centrifuge, door seal, etc.

**Extra parts**

The part accompanies with the complete set of the new equipment e.g. lam for Microscope, as it may incidentally damage or has a short life span.

**Spare parts**

The part reserved for repair and maintenance activity e.g. ICs, diodes, resistor, capacitor, etc., but, this kind of part is difficult to be predicted because we don't know when it breaks down.

Only parts for replacement of moving parts are predicted. Therefore, type and quantity of the parts required for preventive maintenance can be estimated based on its life span. Life span of each part is usually recommended by the manufacturer's manual.

**Life span**

An expected period of time of which a part or equipment functions with safe, and gives reliable and accurate results.

## 1-Introduction

One of the main issues of health service delivery in Cambodia is management and maintenance of Medical Equipment (ME). Especially referral hospitals face difficulties to keep the medical equipment in good condition because of insufficient budget allocation, maintenance and management skill and knowledge.

Ministry of Health (MoH) decided to implement the project, which include promotion of basic ME management and maintenance activity at 4 national hospitals and 18 CPA3 referral hospitals (target hospitals) with receiving technical cooperation by Japan International Cooperation Agency (JICA). The project is named "Promotion of Medical Equipment Management System (MEDEM project)". Department of Hospital Services (HSD) of MoH is the responsible organization for the project and HSD called Engineering unit of National Maternal and Child Health Center (NMCHC) to collaborate for implementation of the project.

MEDEM project takes two approaches in order to achieve the project objectives and they are:

- To strengthen the management capacity of the HSD of MoH and establish ME management system between HSD and target hospitals.
- To organize two types of training course, which are designed for improvement of knowledge and skill of ME technician and ME manager of target hospitals.

This ME guidebook was made by MEDEM project staffs for the training of ME technician as their training text, and also as the reference when ME technician perform ME maintenance activities at their hospital. Before developing this guidebook, project staffs have executed many times of field study and research in order to find an appropriate level of activities which may be performed by ME technician and needs on ME management or ME maintenance. 1<sup>st</sup> edition of the ME guidebook was distributed in January 2007. MEDEM staffs have been continuing upgrade and revised several times and last version is now 5<sup>th</sup> edition.

ME guidebook is composed of two parts, one is general knowledge and technical information (part A), and the other is ME maintenance manual and checklist (part B).

Part A consists of instructions and guide, which ME technician should execute on his/her work field together with knowledge development. In addition useful information are listed such as "how to use testing instrument" and "infection control" etc.,

Part B consists of very practical information and forms for executing actual activity of preventive maintenance or giving a hint for repairing the equipment. This part might be good reference when ME technician works on preventive maintenance of each equipment.

Although it was made for ME technician of target hospitals who receive ME technical training, this guidebook may be used in general by all ME technician of all referral hospitals including CPA2 or 1. Moreover ME manager and ME deputy manager of target hospitals are required to read and understand this guidebook especially part A.



## **2-ROLES OF MEDICAL EQUIPMENT (ME) MAINTENANCE TECHNICIAN**

In order to implement efficient preventive maintenance, inventory management, inspection and repairing of the medical equipment at the National Hospital and CPA3 Referral Hospital, we shall provide following essential point.

### **1. Maintenance Workshop requirement**

Every target hospital should be provided Workshop space at the same location of the hospital building.

The workshop must provide the space where ME technician can carry out following works:

- 1) Preventive maintenance of ME.
- 2) Inspection of functional check of ME which procured newly.
- 3) Troubleshooting and repairing of ME
- 4) Office work (e.g. making periodical report, job record and etc.)

### **2. Role of ME Maintenance Technician**

ME technician will be the responsible person for all of maintenance work of ME (preventive maintenance, minor repair, etc.) and management of the workshop in the hospital. ME technician has responsibilities to provide adequate maintenance services for proper operation and management of ME. He/she should report information to ME manager all the time.

- 1) Maintain all of ME in the hospital to keep good condition according to ME guidebook instruction.
- 2) Manage and arrange the workshop properly according to workshop instruction.
- 3) Prepare and conduct semiannual updating and report of equipment and utilizing condition of ME with Deputy ME manager.
- 4) Make annual action plan and semiannual report of activities of maintenance of ME and workshop work.
- 5) Action taken for failure ME which can not be repaired or solved by ME technician.
- 6) Assist ME Manager any work for maintenance and management of ME.
- 7) Assist medical staffs (Operator of ME) the necessary work for proper operation and maintenance of ME.
- 8) Take any other actions which are required for proper maintenance of ME.

### **3. Job description of ME technician**

It is necessary for the medical equipment (ME) which are installed in the Hospital (CPA3 Referral Hospital and National Hospital) to supply good performance, reliability and sustainability to contribute to patient. Therefore, ME technician should execute the routine maintenance work as much as possible.

1) Develop the Planed Preventive Maintenance schedule

Make the planed preventive maintenance schedule for all medical equipment. The schedules should show the list of the equipments and their interval period to be maintained:

e.g.: for sterilizer

Monthly: Check the door seal, electric cord, etc.

Annually: Check all electrical wiring, safety valve, some damaged parts, etc.

2) Implementation of the maintenance schedule

Carry out the preventive and regular maintenance in accordance with the Planed Preventive Maintenance schedule which is mentioned above for all medical equipment, using the "Maintenance Check list (attached with ME maintenance manual on the ME maintenance guidebook, Part B)".

And also, it is useful to apply the manufacturer's maintenance manual developed for some specific equipment.

**Note A: Scope of maintenance**

For the time being, maintenance technician at Referral Hospitals and National Hospitals should carry out physical maintenance (Visual and functional inspection) only. It is not necessary to dismantle and do trouble shooting inside of the equipment. Routine or daily check is most important work to keep proper condition, reliability and life span for the equipment.

**Note B: Advice for the preventive maintenance work**

The first step in preventive maintenance is that equipment is used and kept in suitable environmental conditions.

These items are the indirect maintenance check points of the medical equipment, but it could reduce some of failure or trouble of the medical equipment if you could check it regularly.

- a) Electricity supply
- b) Water supply
- c) Ambient conditions
- d) Dust and moisture
- e) Animal effects

The second step of preventive maintenance is to use common sense in operating the medical equipment and to know the limits of operation of the equipment. This includes regular visual inspections.

- a) Visual check: some crack, injured or broken of external body of equipment.
- b) Functional check: turn on the power indicator properly, check the signal of the lamps, no abnormal sound, or smell, etc.



- c) Specific operating condition: depend on the equipment, respective medical equipment has specific function and feature, also it is important to check properly.

Further detail, refer to the **“ME Maintenance manual and maintenance check list attached in the ME maintenance guidebook, Part B”**.

- 3) Deal with the Maintenance Job Record and Maintenance check list

After carry out the preventive maintenance of ME in each time, ME technician should fill in to the **“Maintenance Job Record (Attached in the ME guidebook Part A)”** and **“Maintenance Check list”** for each medical equipment.

- 4) Updating of the Medical Equipment inventory data

ME technician should update the equipment and utilizing condition of each medical equipment to fill in the **“Check sheet for Monitoring of ME condition (Form 3-2)”** every 6 month.

- 5) Make annual action plan and semiannual report of maintenance activities of ME and workshop

ME technician should make annual action plan bases about your responsible work on maintenance, repairing and workshop arrangement. Fill in on the **“Form 3-1 Annual Action Plan of ME technician”** every December annually.

Also, ME technician should make semiannual report including equipment and utilizing condition of ME; latest updated and information about problem and issue cannot be solved by ME technician own self, etc.; and other useful information about all of ME to submit Deputy ME manager.

- 6) Action taken for failure equipment

When you face some problems or failure of equipment which is not able to solve by your effort and your ability, you must follow the procedures described in **“ME Service request flow”**.



## Medical Equipment Maintenance Job Record

Date:

Province name:	
Ward name:	
Equipment name:	
ID No.:	
Manufacturer/maker:	
Model:	
Serial No.:	
Installation date	
Maintenance Category:	<input type="checkbox"/> Regular maintenance <input type="checkbox"/> On demand maintenance
Natures of defect:	
Equipment fault found on:	
Activities carried out:	
Results:	<input type="checkbox"/> Succeeded <input type="checkbox"/> Not succeeded
If not succeeded, please specify the reasons:	
Comments/ suggestion for rectifying the failure:	

Seen and approved  
Signature and Name  
ME Manager/ Deputy Manager

Seen and approved  
Signature and Name  
Chief/ Vice-chief of Ward

Signature and Name  
ME Technician

### 3-MEDICAL EQUIPMENT SERVICES REQUEST FLOW

Always, ME technician should consider, what is main role on Medical Equipment maintenance? The main role is preventive maintenance and check for Medical equipment in respective hospital. Therefore, it is most important to perform the routine maintenance in accordance with maintenance schedule.

However, it is necessary to think in this chapter, when some medical equipment is broken down at your hospital, if it is impossible to repair or recover by your effort and ability; we recommend the following useful procedures and methods for solution.

Maintenance technician should execute the following procedures:

- 1) Check detail condition of trouble for medical equipment, and record about it. In this time, do not forget to fill up manufacture, model, serial number, etc.
- 2) Based on the Job record which is filled up already, Maintenance Technician should inform and report about this problem to ME manager of your hospital immediately.
- 3) ME manager, after received the report from maintenance technician, should undertake to solve the trouble of medical equipment as quick, easy and economically as possible.

It can be recommended following methods

#### 1. Is it possible to correspond with external service at the local site?

- 1) Find private small workshop service

For example:

- Repairing of Refrigerator / Freezer: (Replacement of cooling gas, welding of gas tube, etc.)
  - Equipment which is running with water processing system (Water distiller, Sterilizer, Dental Chair unit, etc.) Repair of plumbing, alteration of leakage, welding and processing, etc.
  - Repair of simple electric circuit (Incubator, Water bath, Operation light, Magnetic stirrer, etc.), electric installation, heater element, thermostat, and lamp replacement. Use private workshops for domestic electric appliance.
  - In case of mechanical failure, it is possible for processing, repairing of mechanical parts at machinery workshop where placed with Press machine, lathe, drilling machine, etc.
- 2) Find service from local agent or distributor of medical equipment at the local site in Cambodia.



## 2. When impossible to correspond at the site

If you could not find any service mentioned above by your hospital level, it is possible to request to MOH for maintenance service through OD and PHD.

The procedure is as follows.

Fig. 1 shows the Service Flow for medical equipment maintenance & repair relationship flow chart for functional relationship and communication between CPA 3 Referral Hospital and Ministry of Health.

Simple corresponding procedure in case of failure of medical equipment is described as follows:

- 1) Maintenance technician at the hospital should record in the Maintenance Job Record (please refer to Maintenance Job Record in Role of Maintenance Technician at CPA3 RHs and National Hospitals) about trouble or failure condition of medical equipment in detail, and then submit to ME Manager of referral hospital.
- 2) ME manager should report it to the director of the hospital with a copy of Maintenance Job Record.
- 3) The director of the hospital should report to the director of PHD with a copy of the Maintenance Job Record, or makes request letter to MoH for maintenance service through OD and PHD (please refer to sample-1 of request letter).
- 4) The director of PHD should request for diagnosis and repairing service of medical equipment to responsible person in HSD of MoH with a copy of Maintenance Job Record (please refer to sample-2 of request letter).

Next page shows the sample of request letter for ME Maintenance from referral hospitals to MoH. And, another page shows the sample of request letter for ME Maintenance from PHD to MoH.



Sample-1: ME Maintenance Request Letter from Hospital to MoH

Kingdom of Cambodia  
Nation Religion King

.....Provincial Health Department  
..... Operational District  
..... Referral Hospital  
No. ....

Address to: Director General for Health

Through:

- .....Provincial Health Department
- .....Operational District

Subject: Request skilled officer for (maintenance/repair) of (machine .....) in  
.....

With regards to the above, I would like to inform that the machine .....broken down  
and it could not be operated for .....

Accordingly, it would be very helpful if you could kindly consider and send skilled  
officer to repair the machine mentioned above.

Respectfully Yours,

Date:  
Hospital  
Director/Deputy Director

Seen and Submitted to the  
Director General for Health,  
for decision on the above  
matter.  
Date:  
PHD director

Seen  
Date:  
Operational District  
Director

Sample-2: ME Maintenance Request Letter from PHD to MoH

Kingdom of Cambodia  
Nation Religion King

From:.....Provincial Health Department  
No. ....

To: Minister of Health

Subject: Request skilled officer for (maintenance/repair) of (machine .....) in  
.....

With regards to the above, I would like to inform that the machine .....broken down  
and it could not be operated for .....

Accordingly, it would be very helpful if you could kindly consider and send skilled  
officer to repair the machine mentioned above.

Respectfully Yours,

Date:  
.....PHD  
Director

Fig. 1. Trouble resolution flow when the Medical Equipment is broken down

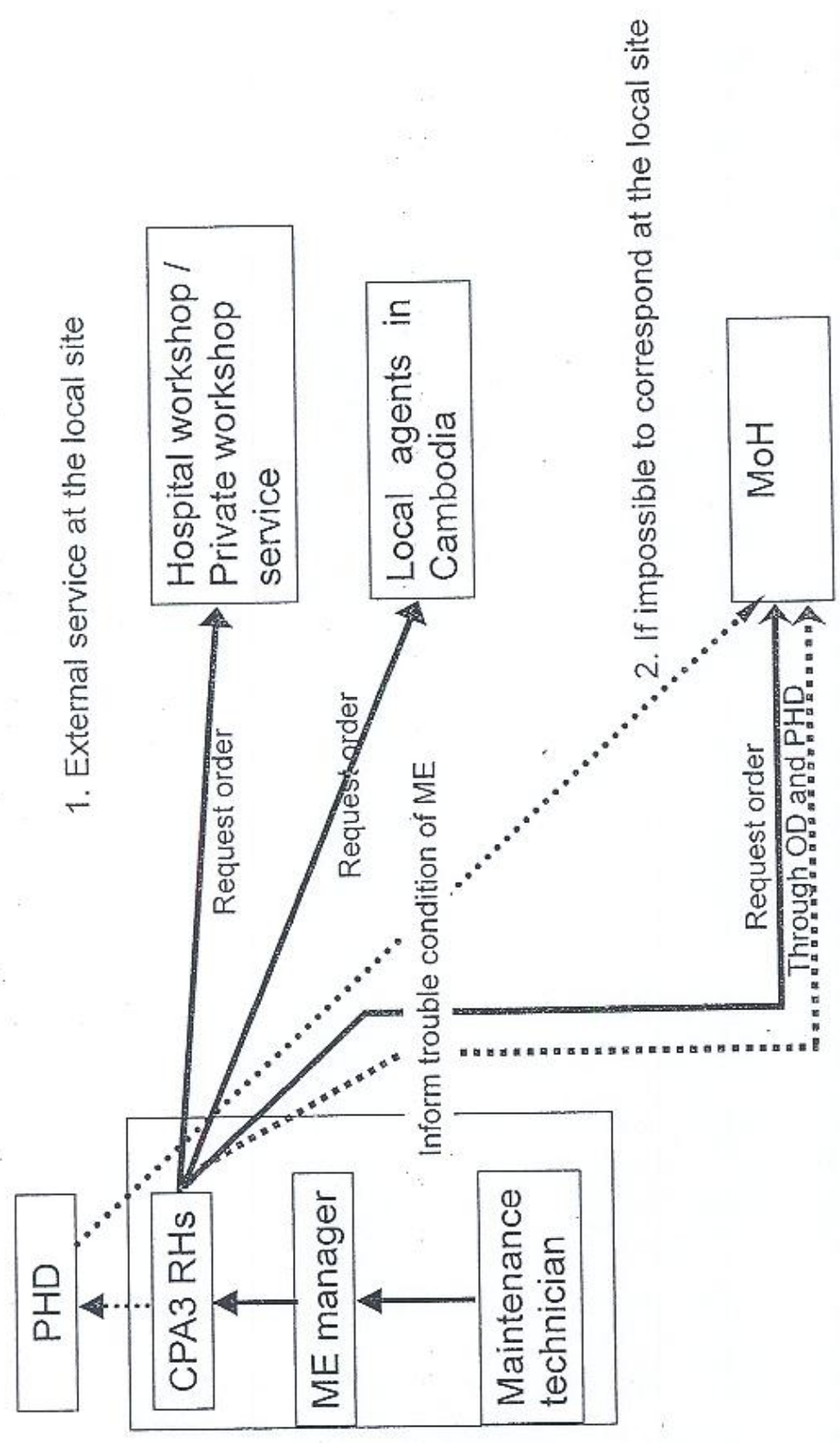



## 4-PREVENTIVE MAINTENANCE

### I. Planed Preventive Maintenance

#### 1. Classification of Medical Equipment

At first step, we sort the names of all medical equipments from the Medical Equipment Inventory List. Then, we can get some important information as follows:

- ❖ Total number of equipments of the same name

For example:

- Ultrasound Scanner 5 units
- X-ray Diagnosis apparatus 2 units

- ❖ The next important step is to read the manufacturer's instructions manual for particular equipment. And then, classify them into the same group for the equipments of those need similar period of maintenance. Doing so, the maintenance work becomes easier.

For example:

- Group A: equipments need to be maintained once very 2 months.
- Group B: equipments need to be maintained once every 4 months.
- Group C: equipments need to be maintained once every 6 months.

Generally, in order to make maintenance work easier for technician, medical equipments are classified into several groups as follows:

### Group of Medical Equipments

Name of equipment	Group	Name of equipment	Group
Anesthesia Apparatus	A	Operating Light	C
Balance	B	Operating Microscope	C
Bilirubin Meter	A	Oxygen Concentrator	A
Blood Gas Analyzer	A	Oxygen Monitor	A
Blood Glucose Meter	A	Patient Monitor	A
Centrifuge	B	Perimeter	B
Chair, Dental Unit	C	pH Meter	B
Chair, ENT	C	Phototherapy Unit	B
Chair, Ophthalmology	C	Pulse Oxymeter	A
Clean bench	B	Refrigerator	C
Colposcope	B	Respirator	B
Defibrillator	A	Retinoscope	B
Doppler Fetus Detector	B	Rotator	B
Electro Surgical Unit	B	Shaker	B
Electrocardiograph	B	Slit Lamp, Applanation tonometer	C
Examination Light	C	Spectro Photometer	B
Fetal Actocardiograph	B	Sphygmomanometer	B
Film Dryer	C	Sterilizer, Boiling	B
Film Viewer	C	Sterilizer, Dry	B
Freezer	C	Sterilizer, Steam	B
Hand Drill	B	Suction Unit	B
Hand Scrub Unit	B	Syringe Pump	A
Hematology Analyzer	A	Table, Examination	C
Hemoglobin meter	A	Table, Gynecology/Ob	C
Hot plate stirrer	B	Table, Operation	C
Infant Incubator	B	Ultrasonic dental scaler	B
Infant Warmer	C	Ultrasound Scanner	C
Infusion Pump	B	Water Bath	C
Laboratory Incubator	B	Water Distiller	C
Light curing unit	B	X-ray film processor	B
Microscope	C	X-ray machine, Dental	C
Mixer	B	X-ray machine, Fixed	C
Nebulizer	B	X-ray machine, Mobile	C



## **2. Essential Medical Equipment**

In general, medical equipments have different functions and advantages. Thus, ME technician should know what equipments are essential for running the hospital such as sterilizers, ECG machine, or other equipment necessary for entity or hospital.

Example: The necessary equipment of Gynecology- Obstetrics hospital are Suction Unit, Infant Incubator, Coagulator, etc.

## **3. Common Medical Equipment**

The medical equipment commonly used to support functioning of the hospital.

The difference between essential equipments and common equipments are as follows:

- Essential equipment: it needs preparation in advance of spare parts for maintenance or repair; or needs preparation of budget for renewal if you expect it will become unserviceable near future.
- Common equipment: this is the second priority; you should also prepare spare parts for it if budget is available.

## **4. Regular Maintenance**

Maintenance of all medical equipments exists in the hospital regularly in accordance with the maintenance schedule. Maintenance staff should make writing proposal of spare parts and necessary budget, especially for essential equipments, and then submit to ME manager or director of the hospital based on technical viewpoints and priority.

Therefore, maintenance staff should carry regular maintenance for both of essential and common equipments to improve the quality of health services, reduce hospital's cost for renewal of medical equipment and to keep long life span for the equipments.

# **II. Procedures to Deal with Maintenance Check Sheet**

## **1. Master Maintenance Schedule**

Master maintenance schedule is a key element for maintenance staff. With this master schedule and information for grouping of the equipment, a detail maintenance schedule can be made for all medical equipments existing in the



hospital.

For example: Master Maintenance Schedule of Medical Equipment in the year 2007

Month	Group of equipment	Type of equipment	Remarks
Jan	C	Regular	
Feb	A	Regular	
Mar	B	Necessary	Sterilizer, Ultrasound Scanner...
Apr	A	Regular	
May		Necessary	Buy spare part for Infant Incubator and Doppler fetus Detector and....
Jun	A	Regular	
Jul	B	Regular	
Aug	A	Regular	
Sep		Necessary	Buy spare part for Sterilizer and probe for Ultrasound Scanner and...
Oct	A	Regular	
Nov	B	Necessary	Suction unit, Operation Light...
Dec	C		

## 2. Maintenance Time

Medical equipment maintenance is a very complicated work since it needs regular maintenance and knowledge in the field of medical engineering. Unfortunately, this subject does not exist in any school in Cambodia.

Moreover, medical equipments are usually used with the patients, thus maintenance technicians should know clearly what time is available for him/her to maintain of which equipment. We cannot perform maintenance when the equipment is being used. For example, maintenance of equipment in OT should be done before 8:00AM.

Generally, it can be said that determining the maintenance time depends on specialty of the hospital and department where the equipment is located in.

*Example of Maintenance Time Schedule*

Department	Time	Person in -charge	Remarks
Blood Bank	09.00	Dr. Ly Sovann	
Dental	10.00	Dr. Dara	Check sheet
Dermatology	08.00	Mr. Vannak	
Emergency	08.30	Miss. Chantach	Check sheet
ENT (ORL)	14.30	Dr. Dara	
Gastro-enterology	14.30	Mr. Meng	
General Medicine	08.30	Dr. Pisey	
Gynecology-Obstetrics	14.00	Dr. Phon	
ICU	09.30	Dr. Mont	
Laboratory	11.30	Dr. Ly Savann	Check sheet
Ophthalmology	15.00	Miss. Sopep	
Operation Theater	07.30	Dr. You Sophart	Check sheet
Pediatrics	15.30	Mr. Sary	
Pharmacy	16.00	Miss Night Im	
Surgery	07.30	Dr. You Sophart	
Infection disease and TB	16.00	Dr. Dara	
Imagery-Ultrasound	10.30	Dr. Hout	Check sheet
Imagery-X-ray	10.30	Mr. Sreng	Check sheet
EKG	10.00	Miss Mout	
OPD	11.00	Miss Sokla	Check sheet
National Program	09.00	Dr. Tha	
Urology	09.00	Dr. Saren	

### 3. Performance

Maintenance should be carried with the presence of the equipment operator. Doing so you are able to inquire some information from him/her, especially for the equipment, which needs to filling in the Maintenance Check Sheet.

In addition, based on the result on the Maintenance Check Sheet, you can give technical advice to the operator at the same time.

Regarding maintenance using Check Sheet, maintenance technicians should follow Manufacture's Instruction Manuals and/or Maintenance ME Maintenance Guidebook of the MEDEM Project. For example: instruction manual for FD-5000 Ultrasound Scanner, operation manual for HDM-100-100 Mobile X- ray unit, instruction manual for STO-140 Dry Heated Sterilizer, etc.



### **III. How to Manage and Control the Maintenance Job Records**

#### **1. Monthly maintenance report**

To sustain routine activities of the Medical Engineering Section and to report these activities to the hospital manager level, ME manager must make monthly report. And then, submit the report to the ME manager or to the director of the hospital every early of the next following month. It means that ME technician must record all of maintenance activities and file them chronologically. With such data, he/she can make monthly report.

#### **2. Repairing Analysis**

Every maintenance record shows ID number of the equipment. So, we can recognize easily the frequency of repair for individual equipment which has been repaired. Finally, we can analyze and decide whether we should stop repairing any of the equipment if its repair cost is high, equal to or higher than purchasing of new equipment.

#### **3. Hard and Soft Document Management**

Every medical maintenance record had been clearly registered its job-code number and the date, so that the activity can be easily followed up.

The maintenance record is very helpful for follow up of activity since it shows service history of individual equipment, for example how many times and when it broke down, how many times and when it was maintained and repaired. Maintenance record paper must be filed chronologically year by year, so that we can easily acquired any information at any time. For example, Maintenance activity report for 2007.

Furthermore, we can entry such record in the Database. Thus, we can easily analyze the data and print it out as a report.



#### IV. Registration and Inventory list

Each stocked and newly procured spare parts is given a hospital code number. information from the invoice or spare parts specification is relevant for creating or formulating the spare parts code number; This code is a key to managing the hospital control of spare parts . On the other hand , the manufacturer's code number is essential to procure spare parts correctly.

The following information is necessary for spare parts registration:

- **Name of spare part:**

- **Code number :** Original number of the hospital. Several parts of numbers are adapted with the ID number of Equipment, which uses the spare parts .The indentification number that shows parts and items in this ID is added.

Example:

Equipment ID number  
SR-007

Code of Spare parts

SR-007-01

Serial number of spare part that is put instead of equipment identification and serial number

Same ID number as equipment

SR: Siem Reap.

- **Manufacturer's code No:** equipment or spare parts that manufacturer gives to equipment spare parts. It is necessary to indicate this number for easy procurement;
- **Specification:** e.g. type, size weight, voltage, name, serial No, and application.
- **Number of content:** The plural quantities might be contained in one package. This may be included in item specification:
- **Name manufacturer:** Name of manufacturers producing the spare parts. It doesn't
- Necessarily conform to the equipment manufacturer:
- **Unit price:**
- **Type of Provision:** is the same the equipment.
- **Name of equipment:** name of equipment that requires spare part:
- **Manufacturer:**
- **Model number:**
- **Serial number:** The specifications of parts are often different even if equipment is of same model. When ordering Spare pats it is importance to indicate serial number of the equipment in order to procure correct parts.

## V. Stock taking

It is necessary to take inventory of the spare parts at least twice a year, during the first half and the second half of the year to ensure accurate number in stock.

## VI. Estimation

All consumable parts have individual lifespan as shown in figure 2.9. The lifespan for each spare part can be determined through the manufacturer's instructions, experiences, ect.

In addition, knowledge in the field of material engineering and safety engineering can be useful. On the other hand, the lifespan of spare parts is also influenced by how equipment is handled and environmental conditions. There fore, estimation of necessary spare parts cannot be done automatically but it is necessary to consider other elements. In a word, although the general principle of spare parts estimation described so far may not apply, a flowchart as shown in figure 2.13 could be recommended. The following procedures are required to be followed when estimating necessary spare parts in large hospital:

- 1- First of all, carry out the survey for utilization of individual equipment and inventory check for spare parts.
- 2- the survey for utilization of the equipment should be done as described in paragraph 2.2.1,
- 3- Ensure that the survey report and equipment list are the same as above.
- 4- Evaluate the utilization of individual equipment items: e.g. fully utilized, partly utilized, not utilized, malfunctioning. Not working and not used with some reasons...
- 5- Choose a medical equipment item concerned.
- 6- Based on the utilization, make a list of necessary spare parts for the concerned equipment referring to the instruction manual, experience, knowledge of material engineering .etc.
- 7- Determine the lifespan of the listed necessary spare parts. The reference matter is the same as step 6.
- 8- Carry out inventory check,
- 9- Report the result of the inventory check,
- 10- Compare the two reports (Step 6 to 9), and determine the kind and amount of the spare parts,
- 11- Procedures (Step 6 to 10), apply to all medical equipment. This information is collated as proposal for submission to the hospital authority.



## VII. Stock Control

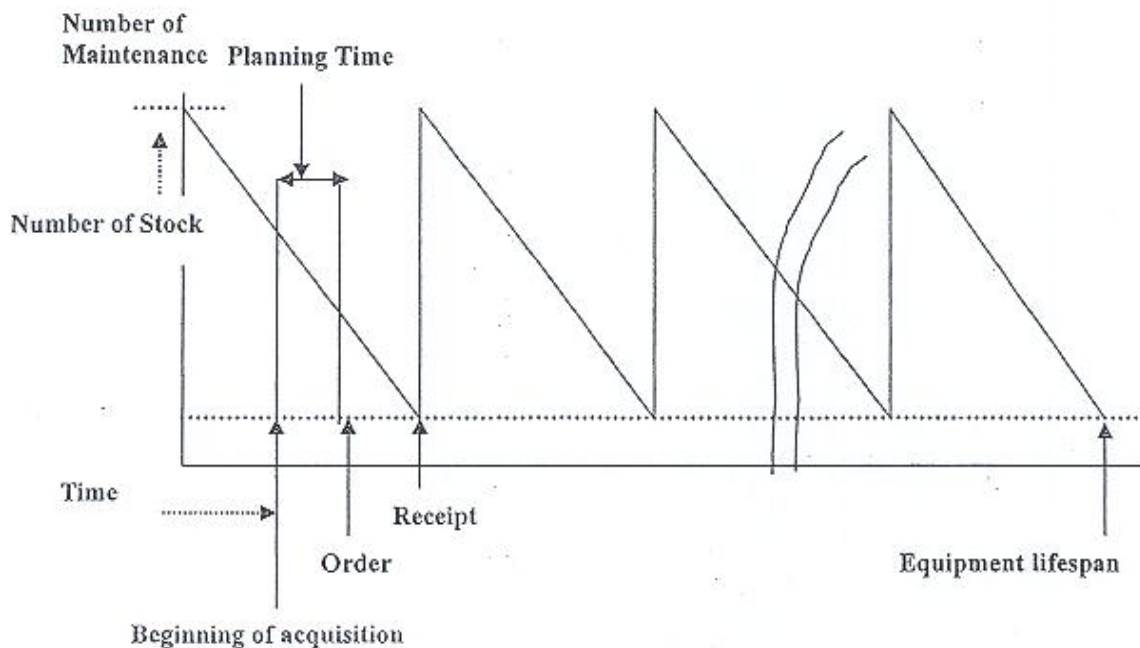

Figure-2 Famous <Saw-curve> Spare parts Stock control.

Capability to manage spare parts in many developing countries remains rather weak. This is not Rational or economical. For instance, the spare parts are just helped up on the floor or casually arranged on the shelf.

In the stock control, the person in charge of store should always monitor inventory figures. The famous <Saw-curve> stock control is usually applied to manage the stock figures as shown in Figure 2.14. However, this can only be applied to the spare parts of short lifespan. Inventory figures are determined first in this Saw-curve. The stock figures depend on the lifespan and stock age of the spare parts, number of equipment, and budget. Planning for procurement is made before the repair parts are reduced to minimum stock. The planning is adjusted according to time taken between ordering spare parts and receiving it.

Final stock figures should reduce to zero at the end of equipment lifespan in order to avoid unnecessary expenditure. To manage stock efficiently, an inventory check to confirm correct stock figures Stocktaking should be carried on a regular basis.

## VIII. Procurement of Spare parts for medical equipment

To procure necessary spare parts, the following should be taken in to account consumption report, selection of suppliers, contact conditions, payment, and stock up to distribution. The procurement committee plays a central role in these processes. In developing countries spare parts procurement is, however, very difficult due to the following reason:



- Most spare parts for medical equipment provided by grand Aid, can not be procured in the local market
- Even suppliers who deal with spare parts exist; they are not interested in dealing with a variety of spare parts for small amount of money
- The unit price of many spare parts that can be bought in the local market is two time or more expensive than regular time
- The spare parts of medical equipment become big financial loads on hospital because of the large amount of money involved
- Personnel who can estimate necessary spare parts and to negotiate on procurement with suppliers lack training

A lot of donated equipment is confronted with shortage of spare parts. Therefore many developing countries find it difficult to sustain the procurement of the spare parts for donated equipment. On the other hand, if the kind and amount of necessities spare parts are uncertain, procurement is also impossible. Technology transfer on spare parts management in developing countries is demanded based on the above reason.

### Actual Spare parts Estimation flowchart:

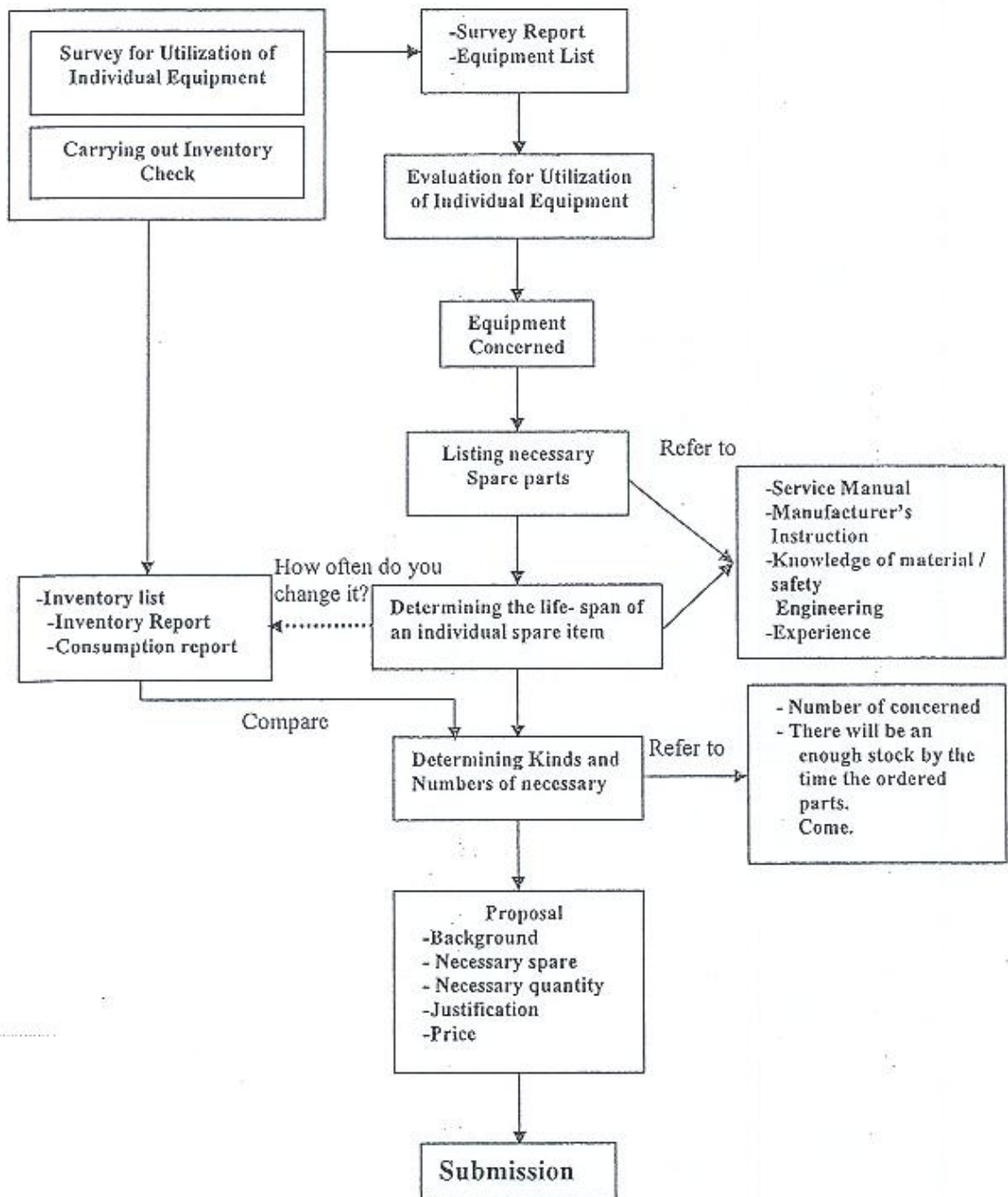

## 6-ROLE OF OPERATOR ABOUT MEDICAL EQUIPMENT

### 1. Introduction

Needless to say, the medical staffs (doctor, nurse, and laboratory technicians, etc.) in hospital have a lot of opportunity to handle and use with the medical equipment the most. Therefore, it is most important that the operator / user must operate and maintain properly in daily basis for adequate working of ME so that its life span will be maintained longer.

If the mistake is found in this use, it will become the cause of the breakdown of ME. Moreover, it is likely to interfere to the patient in the worst case. A serious accident due to trouble and the breakdown of the medical equipment has actually happened on a several medical site in the past.

Most of the cause of these accidents is negligence of improper use and maintenance.

Therefore, it is necessary that the operator should have enough knowledge about ME operation and do regular maintenance in order to prevent above mentioned failure or accident. Also, you have to maintain well the ME performance and its reliability.

Then, let's study the role of operator/user for ME maintenance management in this chapter.

### 2. Cause of Failure of ME

Medical equipment failures take place due to various reasons. In addition, causes of failures are often overlapped. Essentially, they can be classified as follows.

#### 1) Poor design and production deficiencies

Equipment manufacturers always make efforts to produce high quality equipment even in the process of designing electronic circuit and of choosing components. Nevertheless, a few cases of equipment failures due to designing error such as parameter of electronic circuit and improper choice of components would appear after the equipment dispatch to the user. In addition, very often negligence in equipment factories such as insufficient testing and inspection of finished products and absence of training programs for workers may also cause of equipment failures.



In general, when equipment manufacturers discovered equipment defective caused by designing error or producing process, they would announce faulty points of equipment and then repair or recover it.

#### 2) Failures due to careless storage and transport

Poor storage of the equipment such as undue long storage, storage under high temperature/humidity and improper packing may cause of equipment failure. Excessive vibrations and mechanical shocks during transportation may also cause of equipment failure.

#### 3) Initial failures

This failure would appear in the initial use of equipment. Poor circuit design, improper choice of components faults of producing process, etc., may cause of this type of failure.

You may consider that if the equipment became fault in normal operating conditions within one year after the equipment dispatched to the hospital. It could be treated as an initial failure.

In such a situation, reputed equipment manufacturers or suppliers give one-year guarantee to the user. However, they do not give the guarantee recovering failure equipment in which was caused by mishandling or inappropriate operating of the equipment.

#### 4) Random failures

This is an equipment failure, which would occur at random. Experience shows that the equipment is suddenly fail even though it has been in appropriate handling. The number of breakdown during period of random failure is very rare.

This is mostly due to faults in electronic components on the printed circuit board (PCB) such as transistors, ICs, resistors, capacitors, etc. In this case, a high repair technique is required to find the faulty components/parts. In case of inability to find out the faulty components, you shall have to pay a lot of budget as to replace the high cost of PCB.

#### 5) Wear-out failures

The equipment becomes old with the passage of time and faults appear elsewhere that causes further deterioration of smooth working of the equipment. Finally, the equipment becomes unserviceable. However, it must be remembered that almost all of faulty equipment can be rectified by carrying out the preventive maintenance.

#### 6) Failures due to inadequate maintenance

Experience shows that many types of medical equipment become faults two or three years after installation. But causes of such failures are mostly due to deterioration or faults of accessories and consumable components such as filters, lamps, transducers, electrodes tubing and so on. If preventive maintenance was carried out, all such things could be found and the failures could be avoided. Actually, such failures are not called real breakdown. Real breakdowns that semi-permanent components inside/outside of equipment became faults are very rare. On the other hand, medical equipment would gradually lose its performance and safety. This also should be monitored and fixed.

Therefore, the preventive or regular maintenance should be frequently carried out in accordance with manufacturer's instructions in order to keep the proper function, safety and supposed life span of equipment.

#### 7) Failures due to poor repair techniques

Unqualified repair technique could give another cause of equipment failure in the near future, even if it was repaired for the time being. For example, a power transistor which was checked in troubleshooting was burnt out after few days, operation due to excessive development of heat resulting from improper fixing of it with silicon grease and heat sink. In this case, it is not only the fault of repair technique, but also the inadequacy of quality control for repair. It must be remembered that poor repair techniques could cause of damage to circuits or components, which even manufacturer cannot guarantee to restoration of it.

#### 8) Failures due to inappropriate handling and operation

Carelessness or rough handling of equipment can cause of fault and breakdown on it. Some examples are as given below:

- a. Auto balancer: Zero balance could not be adjusted due to rough use of zero adjust knob.
- b. Centrifuge: Motor does not rotate due to misconnection to AC 220V power supply though it is for use on AC 100V.
- c. Bedside monitor: ECG signal does not come on the screen due to corroded print pattern resulting from antiseptic solution was dropped onto the PCB.
- d. Mobile X-ray apparatus: No "Ready state" comes on due to disconnect between the PCB A and B. resulting from rough transporting.



### 9) Failures due to environmental stress

Hostile working conditions such as lack of air-conditioned room, dust free areas, under direct sunlight, etc. may cause of equipment failure; fluctuations of voltage supply and low water quality also may cause of it. These environmental conditions may not only cause of equipment failures but it may also great enemy on keeping equipment's expected life span. Accordingly, the equipment should not be installed and operated in bed environmental conditions as shown in Figure 1.2.

Cause of failure of ME can be divided roughly into the above mentioned. However, generally, 6) and 8) mostly rank up.

Following Figure is that the result of analysis of cause of failure for ME in one of General hospital for one year in Japan.

As you see, If you can operate ME properly, you can avoid much case of breakdown and failure of ME.

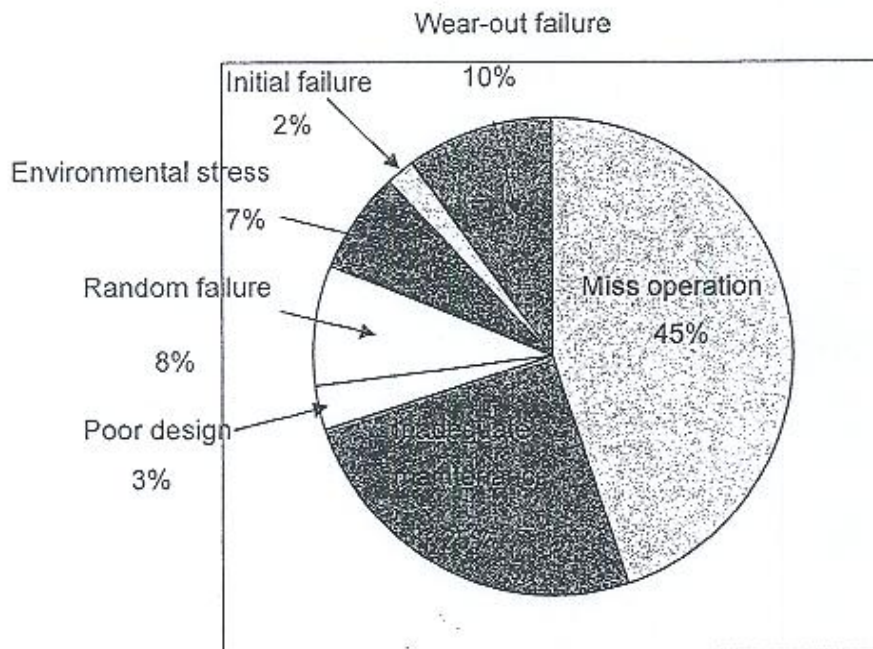

### 3. Operator / User should acquire appropriate method of operation for ME

Adequate method how to operate and handle with ME is following.

- 1) You should peruse well the instruction manual that is attached from manufacturer. Especially, operator should acquire the knowledge of



precautions during using period.

- 2) Operator/user receive some training or education program about how to operate the ME from the person who know the ME (e.g., Manufacturer's engineer or ME maintenance technician, etc.).
- 3) Operator should master proper operation and handling by repeating to operate the ME sufficient times.

#### 4. Environmental condition for installation place of ME

Environmental condition for installation place of ME is also important matter as cause of failure of ME.

The ME will be failed or breakdown by effect of electricity supply, room temperature/humidity, dust, gasses and inserting of some foreign object, etc. That is why maintenance of environmental condition is also very important issue.

This is not direct maintenance of the ME but it reduces the overall maintenance required for the ME. The following environmental conditions should be checked and controlled.

- 1) Electricity supply
- 2) Water supply
- 3) Ambient conditions
- 4) Dust and moisture
- 5) Animal effects

##### 1) Electricity supply

Many items of ME need electricity to operate. Most of these items can only operate on a limited range of electricity. It is therefore important that the supply of electricity falls within this range. It sometimes happens that there is a loss of power, a surge of power, very low voltage or fluctuations of the supply voltage. Many times of equipment give inaccurate readings, fail and breakdown because of a poor quality of power supply. It is reported that an unstable electricity supply is one of the major causes of equipment failure.

The standard electricity supply in Cambodia is 220 V AC, 50Hz for single phase supply or 380V AC, 50Hz, for three phase supply. Most ME can operate in a  $\pm 10\%$  range of this.

**Check that :**

- There is a stable voltage supply
- Voltage and frequency of the equipment and the supply are the same.
- Voltage and frequency at the outlet are within the range started on the equipment.
- The plug of the equipment matches the socket in the building, where applicable
- The equipment can be properly earthed through the distribution system, where required.
- The distribution system is properly protected by fuse or circuit breaker.

**These checks must be made or conditions confirmed on a regular basis.**

If instability of power supply causes of equipment the following may overcome this problem:

- Voltage regulators can be used with equipment such as computers and other sensitive instrumentation or equipment.
- UPS can be used with essential and precise equipment; such as computer, operation theaters equipment or life support system equipment.
- Automatic voltage Regulators can be used for all or the major part of facility.

## 2) Water supply

Poor water quality, high or low pH, hard water, dissolved chemicals, can affect the condition of ME having water circuits or using water (e.g.: Water distiller, Water bath, Spectrophotometer, Ice maker, High pressure steam sterilizer, etc.) by corroding the equipment, it work less effective or blocking pipes. Contaminated water can distort laboratory results.

**Check that:**

- There are no signs of corrosion/leaks at the water outlets/tap.
- The water pH and hardness are within the limits stipulated in the WHO standard.
- There are no signs of "scaling" in water boilers, kettles or similar.
- Water filter elements are clean and
- There are no places in the water storage distribution system where the water can be contaminated.

**These checks must be made or conditions confirmed on a regular basis.**



Carry out the following to minimize contamination of the water supply:

- Flush out those parts of the system where water has not been used by opening the tap and let water flow for a few minutes.
- Clear any safety relief valves on pressure equipment. Blocked relief valves can cause the equipment to explode.
- Repair all leaks.
- Where necessary a water filter must be used.

These actions must be carried out on a regular basis.

### 3) Ambient conditions

Many types of equipment operate satisfactorily only within certain ranges of temperature and humidity. Even though the ambient temperature in Cambodia is usually below 35°C, inside rooms it can be much higher. Certain reagents and chemicals used with medical equipment must also be used and stored within a temperature range.

Check:

- The temperature in the room where the equipment or material is to be used or stored.
- The humidity in the room where the equipment or material is to be used or stored.
- Care of the installation place for the ME where is under the direct sunlight.
- Care of the installation place for the ME where is under the interference of the radiating energy or heater.

Note:

- Storage temperature can affect the shelf life of a material. Material that has passed its shelf life must be disposed off.
- Some equipment has facility for temperature compensation.

Where the temperature or humidity is too high the following can be done to overcome the problem:

- Install air conditioner. (Fans do not modify the air and cannot be used to cool a room)
- Use a refrigerator or freezer for materials which must be controlled cooling condition.
- Install anti condensation heaters in equipment that can be affected by condensation.

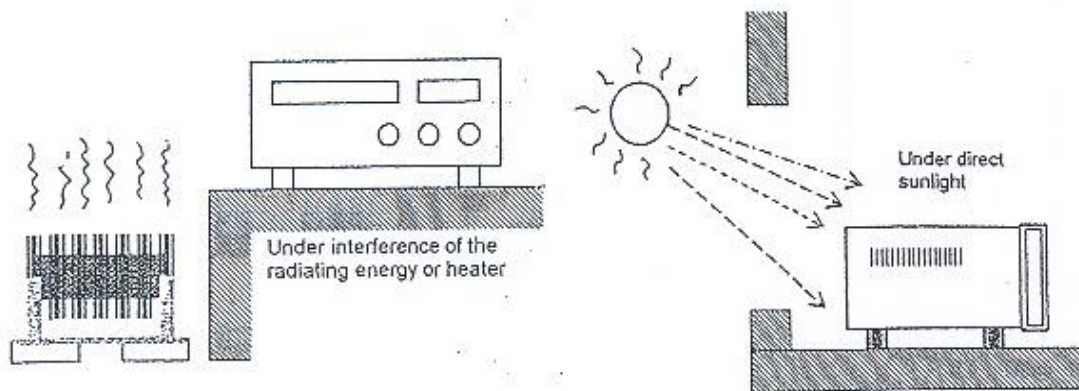

#### 4) Dust and moisture

The corrosive effects of dust and moisture can cause malfunctioning of medical equipment.

Check that:

- ☉ The equipment is free from dust, moisture and any other encumbrances.

These checks must be made on a regular basis.

Carry out the following to minimize adverse effects of dust and moisture:

- ☉ Prevent dust from entering rooms.
- ☉ Clean rooms.
- ☉ Keep air flowing in rooms to prevent "condensation" settling on equipment.
- ☉ Store equipment under its dust cover.
- ☉ Store equipment in dust proof cupboard or appropriate place.

These actions must be carried out on a regular basis.

The following precautions should be taken when storing or using equipment.

- ☉ Do not store or use equipment close to water containers, pipes or in places where there is likelihood of water dripping or splashing on it.
- ☉ Do not store or use equipment too close to an air conditioner unit. It will become cold and when the air conditioner is turned off or the equipment is moved to a warmer area condensation will form on the equipment.
- ☉ Do not store or use equipment where there is a presence of flammable gases, high temperatures, high humidity, insufficient ventilation, sunlight, dusty, salty or sumptuous air or where there may be vibration and impact to the equipment.



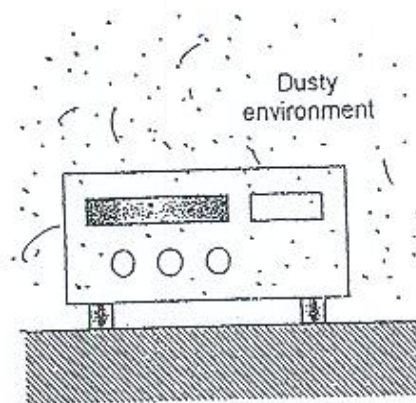
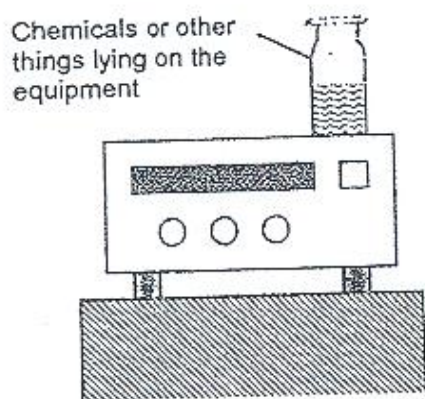

### 5) Animal effects

Equipment can be damaged by insects such as ants, spiders, cockroaches, etc. when they build nests or leave droppings. Small mammals such as rats and mice like to gnaw electrical wires.

Animals can also carry diseases and equipment can become infected and non sterile.

#### Check that:

- The equipment is free from the effects of animal presence by looking for droppings, webs, trails, nests, damaged electrical wire, corrosion marks, etc.

These checks must be made on a regular basis.

Carry out the following to minimize adverse effects from the presence of animals;

- Keep the facility clean.
- Prevent animals from entering the facility by keeping doors and windows closed, using insect screens over windows, closing any hole in the building where animals can enter, keep water containers covered.
- Clean equipment before using it.
- Store equipment in an insect proof cupboard.
- Store sterilized equipment in special containers.
- Place insect and rodent baits.

## 5. Regular maintenance of ME by Operator / user

Doctors and nurses at the hospital operate most of the equipment in general. Wherever necessary they are provided appropriate training for proper operation and handling of ME. Also, the maintenance should be carried out under responsibility of operator.

The medical equipment becomes fault with the passage of time resulting from the degradation, wear-out and/or breakdown of its components. This status is called the "wear-out failure". Normally, the number of years, which it reaches, is may be 5 to 6 years. However, wear-out failures could be avoided by carrying out the preventive maintenance.

As the first step of preventive maintenance is that clean up the equipment at inside and outside. The operator should daily or frequently take care of equipment cleaning up enclosure and applied parts of the equipment. Such simple maintenance prevents the breakdown of the equipment and also keeps the expected life span of equipment.

The preventive maintenance is to use common sense in operating the equipment and to know the limits of operation of the equipment should be done by operator / user.

This also is not direct maintenance of the equipment but it reduces the overall maintenance required for the medical equipment. This step involves the operator of the equipment as the prime person to perform these tasks. Maintenance technicians should coordinate and cooperate with the operators in cases where the operator is not the maintenance technician also. If the first step in preventive maintenance is followed there should be no need to check that the equipment is clean and free from dust and moisture, it should be.

Equipment should be inspected for external damage every time it is used and checked that it is functioning properly and in accordance with the required parameters for the equipment. The operator or the person doing the inspection should report any prospective fault, actual fault or malfunction as soon as it happens and not use the equipment if it could cause further damage or have adverse effects on the patient or operator.

Maintenance which can be done by operator/user should include the following:

### 1) Visual Inspection

The inspection is carried out by naked eyes and/or hands to confirm the physical injury and ruggedness of the equipment without operation. Table 1 show an example of the items, which is to be visually inspected for Patient Monitors.



**Visual Inspection:**

The inspection is carried out by naked eyes and/or hands to confirm the physical injury and ruggedness of the equipment without operation. Table 1 show an example of the items, which is to be visually inspected for Patient Monitors.

Check that there is no physical damage of the equipment, including:

- that there is no corrosion (rust), dents, paint chipped on or in the equipment,
- that plugs and sockets fit snugly,
- that electrical cords and cables are not damaged or frayed,
- that adjusting and switching knobs are not cracked, chipped and have their indication point clearly marked and visible.
- that the equipment is stable and has no missing "feet", casters are not broken and are all operating properly (including the locking device),
- that indicators and displays have no cracked or broken lenses or covers,
- that all labeling is completed and legible,
- that there are no sharp edges or burrs on the equipment that could cause injury and anything else that could indicate that the equipment may require some form of repair.

**If any damage is found the following actions should be taken as applicable:**

- ⊗ Clean the equipment if it is only a bit dirty.
- ⊗ Change any electrical cords and accessories if they are damaged.
- ⊗ Record the damage and the eventual actions taken in the Job record.
- ⊗ Make arrangements for the maintenance or repair of the equipment.
- ⊗ Set the equipment aside if the damage is likely to cause a dangerous situation. Do not use the equipment until after it has been maintained or repaired.
- ⊗ Maintain or repair the equipment using the basic guidelines.



Table 1. Items of Visual inspection with an example of Patient Monitors

Inspection item	Description
1. Accessories and consumables	<ul style="list-style-type: none"> <li>● Are mains cable, earth cord and induction cord normal?</li> <li>● Are electrodes, relay cable, cuff hose, gel, etc. complete?</li> <li>● Is an operating manual available?</li> </ul>
2. External packing	<ul style="list-style-type: none"> <li>● Broken enclosure of main body</li> <li>● Cracked/broken panel</li> <li>● Missing characters</li> <li>● Rusts/dents on the main body</li> <li>● Cracked/broken knobs or switches</li> <li>● Gripping force between mains plug and mains socket</li> <li>● Loosened screws</li> </ul>
3. Electrode, Sensor, Cuff and their connections	<ul style="list-style-type: none"> <li>● Rusty or contaminated electrodes</li> <li>● Spring muscle of PaO<sub>2</sub> sensor</li> <li>● Absorption effect on electrode</li> <li>● Hose connection of cuff</li> </ul>
4. Terminals, etc.	<ul style="list-style-type: none"> <li>● Broken earth terminal</li> <li>● Rough terminals</li> </ul>
5. Display	<ul style="list-style-type: none"> <li>● Brightness on the screen</li> <li>● Burnt phosphor screen (CRT)</li> <li>● Picture damage on the screen (LCD)</li> </ul>
6. Caster	<ul style="list-style-type: none"> <li>● Smooth movement</li> <li>● Stopper</li> <li>● Level surface</li> </ul>

## 2) Functional inspection

This inspection deals with the handling and functioning of equipment. The functional inspection is performed in three steps, i.e., preparation for operation, during operation and after operation of equipment. Table 2 show an example of the items, which is functionally inspected for patient monitors.

### **Functional inspection**

Check that all functions of the equipment are normal when using and after switching on, including that:

- selector switches are switching
- indicating lights are operating
- adjustment knobs/potentiometers are working
- the electronics cooling fan is working
- meters are indicating, set to zero where applicable
- beeper and other sound warnings are operating and audible
- there are no unwanted, unnecessary humming or crackling noise
- The brightness on the display screen is satisfactory and uniform, no damaged
- There is sufficient ink in recording machines
- Anything else that could indicate that the equipment may not be able to function at 100%

If any part of the equipment is found to be non functional the following actions should be taken as applicable:

- ⊗ Change any electrical cords or accessories if they are damaged.
- ⊗ Change batteries, light globes and similar small replaceable items if applicable.
- ⊗ Record the damage, change of item and the eventual actions taken in the log book.
- ⊗ Make arrangements for the maintenance or repair of the equipment.
- ⊗ Set the equipment aside if the damage is likely to cause a dangerous situation. Do not use the equipment until after it has been maintained or repaired.
- ⊗ Maintain or repair the equipment using the basic guidelines.



Table 2. Items of functional inspection with an example of Patient Monitors

Inspection item	Description
1. Preparations (Before operation)	<ul style="list-style-type: none"> <li>● Confirming first positions of function switches, accessories, etc.</li> <li>● Connections of accessories, i.e., ECG lead, SaO2 sensor and cuff, etc.</li> <li>● Connection of main cable</li> <li>● Inspection of mains cable and earth connections</li> </ul>
2. During operation	<ul style="list-style-type: none"> <li>● Turn the switch the equipment on.</li> <li>● Confirm about anything seems to be wrong around the equipment, e.g., flame, smoke, unusual smell, sound, heating, etc.</li> <li>● Confirm the indication lamp lights, display, etc.</li> <li>● Confirm for proper setting knobs/programmes.</li> <li>● Is there any noise or interference?</li> <li>● Are all functions of switches normal?</li> <li>● Is AC power – battery power selection normal?</li> <li>● Is battery charge normal condition?</li> </ul>
3. After operation	<ul style="list-style-type: none"> <li>● Returning function switches to the fast set position.</li> <li>● Return the power switches off (Next procedure should be done after 20 – 30 seconds).</li> <li>● Take off electrodes, cuff etc. and arrange them.</li> <li>● Make the equipment ready for next operation / use.</li> </ul>

It is necessary to execute the work mentioned above for the user who handles the medical equipment to acquire appropriate knowledge enough, for the medical equipment to operate normally, and to maintain reliability for a long term efficiently.

Finally, I recommend that The ME technician support to operator / user about training of proper operation and handling, also daily maintenance can covered by operators in case of necessary.

## 7-BASIC CLINICAL ENGINEERING

### 1. Concept of Clinical Engineering

A lot of medical equipment is introduced to use at hospital and medical institution as develops of advanced Medical Technology in recent years.

If there is no medical equipment, we can not carry out diagnosis or treatment for supplying good medical service to the patient.

Nowadays The Clinical Engineering is a technical field where the engineering technology is directly applied on the clinical site. And, talent who is providing with this technology and the qualification is called Clinical Engineer.

Various kind of medical equipment and machine are developed and utilize into the clinical site actually. Clinical engineer should not only use them efficiency but also have to take care to save the security, reliability, and economy. Therefore, it will be necessary some specialist who take responsibility for operation, maintenance, and management of medical equipment.

Actual implementation roles of Clinical Engineer are following table (Refer to Table1).

*Table 1. Implementation role of Clinical Engineer*

Operation of Medical equipment	<ul style="list-style-type: none"><li>➤ Adjustment, calibration and maintenance check before operation.</li><li>➤ Setup between patient and medical equipment.</li><li>➤ Operation, monitoring, measuring and recording during diagnosis and treatment.</li></ul>
Maintenance of Medical equipment	<ul style="list-style-type: none"><li>➤ Planed preventive maintenance, diagnosis and repair.</li><li>➤ Maintenance record, inventory works.</li><li>➤ Clean-up, Maintenance check after operate the medical equipment.</li></ul>
Education for Medical staffs	<ul style="list-style-type: none"><li>➤ Education for patient.</li><li>➤ Education for medical staff</li><li>➤ Contact with manufacture</li><li>➤ Information, communication work</li><li>➤ Brush-up training for Clinical Engineer.</li></ul>



## 2. Body fluid and blood

Moisture contained in the human body is called the *body fluid*, and it is shared in 60% of the body weight (see Figure 2.). Total volume of the body fluid is called the mass fluid volume containing intracellular fluid (ICF: shared in 40% of body weight) and extra cellular fluid (ECF: shared in 20% of body fluid). ECF is classified as tissue fluid

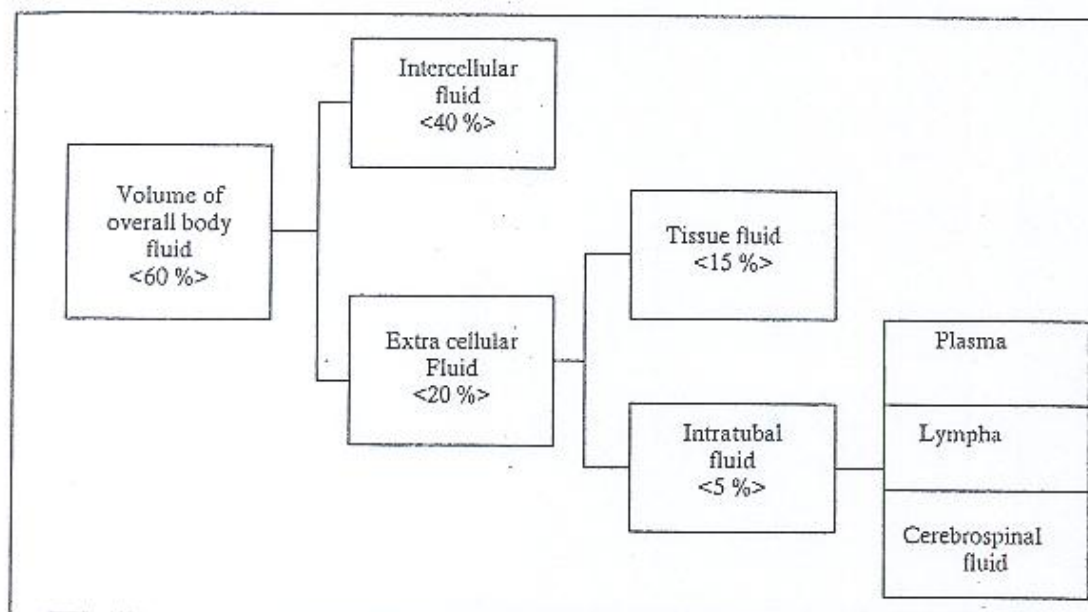

Figure 2. Volume of overall body fluid and its formation

(Shared in 15% of body weight) and intratubal fluid (shared in 5% of body weight: blood plasma, lymph fluid and cerebrospinal fluid). Body fluids are ingested from drinks, moisture inside of foods and moisture generated in process of metabolism, and they are excreted as urine, feces and transpiration (discharged from skins and lungs, but sweat is not included) as shown in Table 2. Balance between the input and the output a day is almost equal. Excessive moisture inside of the body causes edema, and losing moisture causes dehydration.

Table 2. Input/output of moisture a day for adult

<i>Ingestion</i>		<i>Excretion</i>	
Drinks	1,500 ml	Urine	1,500 ml
Moisture inside of food	800 ml	Transpiration	1,000 ml
Combustion water	300 ml	Feces	100 ml
Total	2,600 ml	Total	2,600 ml

Body fluid contains positive ions (e.g.,  $K^+$ ,  $Ca^{2+}$  and  $Mg^{2+}$ ), negative ions (e.g.,  $Cl^-$ ,  $HCO_3^-$ ,  $HPO_4^{2-}$  and  $SO_4^{2-}$ ), organic acid ions (e.g., lactic acid and uric acid) and protein ions as shown in Table 2. Most of the positive ions in extra-cellular fluid are  $Na^+$ , and in intracellular is  $K^+$ .

The concentration of the electrolyte (ion) is represented in the unit of mille equivalent, mEq/l. Excessive or less electrolyte causes of electrolyte ataxic diseases, e.g., hyperkalemia (creating arrhythmia and abnormal rhythm on ECG), hypocalcemia (causing of convulsions) and hypernatremia (causing of high blood pressure and edema).

Table 3. Formation of serum electrolyte

Positive ion		Negative ion	
$Na^+$	142	$HCO_3^-$	27
$K^+$	5	$Cl^-$	103
$Ca^{2+}$	5	$HPO_4^{2-}$	2
$Mg^{2+}$	3	$SO_4^{2-}$	1
Total	155 mEq/l	Organic ion	6
		Protein ion	16
		Total	155 mEq/l

Body fluid's pH is being kept within 7.35 - 7.45. The body fluid is one kind of the buffer solutions, and its pH is controlled by means of buffer action between breathing, plasma proteins and hemoglobin, functioning of metabolic wastes in kidney and so on. Abnormal pH in the body fluid is called the acid-base balance disorder. It is called the *acidosis* where pH is less than 7.35 and *alkalosis* in pH more than 7.45. Accumulation of  $CO_2$  due to respiratory insufficiency causes of respiratory acidosis, and losing  $CO_2$  due to hyperpnea causes of alkalosis. Abnormal pH due to accumulation of acid or alkaline is each called *metabolic acidosis* and *metabolic alkalosis*.

Figure 3. Various kinds of blood ingredient and plasma

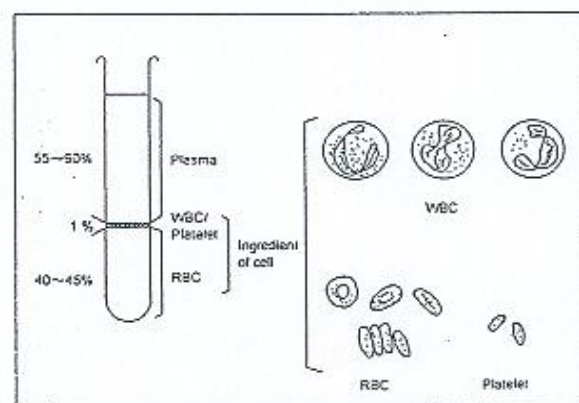



Blood consisted of blood cell and blood plasma is shared in 7% of the body weight. The blood cell is shared in 40 – 50 % of the blood volume, called the *hematocrit volume*, and is consisted of *Red Blood Cells*, *White Blood Cells* and *Platelets* (see Figure 3).

Red blood cells are disk-shaped, about 7.7  $\mu\text{m}$  in diameter and 2  $\mu\text{m}$  thick, and there are 5 million red blood cells in the blood of 1  $\text{mm}^3$ . Red blood cells have the vital role of carrying oxygen to all the cells of the body; also pick up waste carbon dioxide for removal. Red blood cells contain a large, complex protein called *hemoglobin*. Hemoglobin has changed to oxygen and carbon dioxide that the red blood cells transport.

White blood cells help the body to fight the disease. Leukocytes make up only about 1 percent of the total volume of blood, and they are outnumbered by red blood cells by 500 to 1. White blood cells are much larger than red blood cells, having nuclei and organelles.

Lymphocytes involving immune system manufacture antibodies that of protein substances in the plasma, which combat specific diseases.

Various kinds of substances are dissolved inside of plasma such as organic substances (e.g., glucose, lipid and protein), inorganic substances (e.g., electrolyte and mineral), hormone, enzyme and blood gases (e.g.,  $\text{O}_2$  and  $\text{CO}_2$ ).

Classification of the blood type is commonly used of ABO type and Rh type. ABO type is classified into 4 categories, i.e., A, B, AB and O. Rh type is classified into 2 categories, i.e., Rh (+) and Rh (-).

### 3. The Circulatory system

Circulatory systems consist of the system transporting blood and body fluid, heart, blood vessel, lymph, and spleen. The heart is really two pumps in one organ (see Figure 2.7). The heart consists of atriums and ventricles in both left and right sides, vessels (aorta, pulmonary artery) ejecting blood from the ventricle and another vessels (large veins, pulmonary veins) guiding blood to atriums, semilunar valve (aortic valve, pulmonary valve) and bicuspid valves (mitral valve, left atrioventricular valve). The blood coming out from the left side of the heart is circulated to the rest of the body as follows:

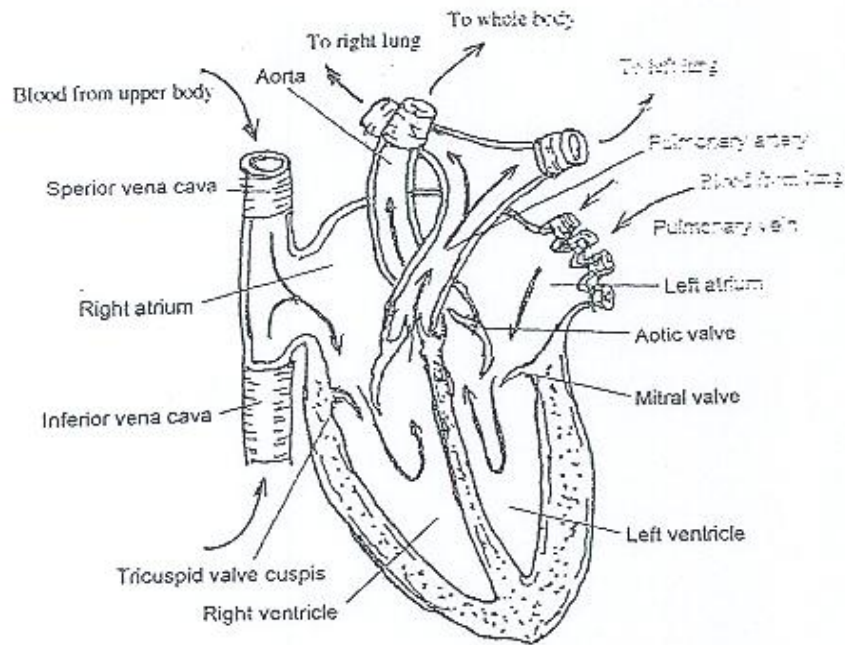
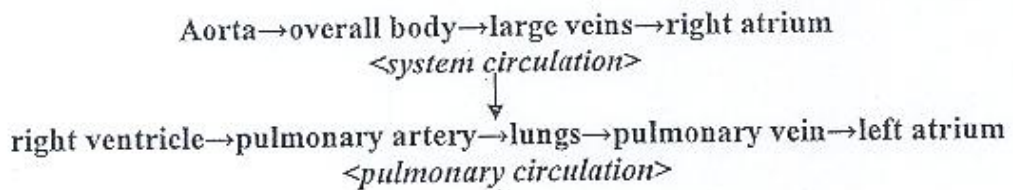

Figure 4. Structure of Cardiovascular



The portal vein is a systemic circulation that brings digested/ingested nutrients from the bowels to the liver.

The heart ejects the blood of 60–70 ml at its one contraction, called *stroke volume*. Output volume in one minute is called *cardiac output*; 4–5 l/min for normal adult in rest and 20–30 l/min in exercise.

#### 4. The Excretory System

Up to 25% blood out of the cardiac flows in the kidney. This is called the renal blood flow (RBF, 1,200 ml/min). Where hematocrit is 45%, the renal plasma flow (RPF) is of approx. 660 ml, and 20% of RPF volume filtered by glomerulus in which urine forms; this is called the *glomerular filtration rate* (GFR).



About 190 l of fluid from the blood passes through the kidneys each day. Not all this fluid becomes urine. Most of it is returned to the bloodstream, along with water, glucose,  $\text{Cl}^-$ ,  $\text{Na}^+$ ,  $\text{K}^+$ , vitamins and other substances needed by the body. Only about 1 or 2 l of fluid are actually excreted as urine.

## 5. Electrical shock

Most important thing that should be concerned in electrical safety is electrical shock. Experience shows that we often feel an electric current flow while touching old equipment with our fingers, e.g., an old centrifuge in the hospital laboratory. In this situation approximately 1 mA current flows from hand to the surface of the body, and then to the earth; it is for normal adult. It could be said that this feeling is the safety limit for the human body.

When the current value is 10 to 20 mA, we shall unable to leave our hand from its touching point because we are no longer in control of muscles of our hands or legs by ourselves due to the high electric current. This limitation is called elimination current. If the current value increases that of more than 20 mA, it will flow into the body and to the heart in which results ventricular fibrillation or pump failure: Current value that gives ventricular fibrillation or pump failure may be 200 mA. Such electrical shock occurred when the current flows into the body via skin and again comes out of body is called *macro-shock*.

On the other hand, without passing the skin, when the current flows inside of the body and it directly exerts the heart, even a 1 mA current value causes of death as a resulting from ventricular fibrillation. Such electrical shock is called *micro-shock*.

Figure 5. Dispersion of conductivity on each organ: in case of dogs at 37°C, 1~100kHz

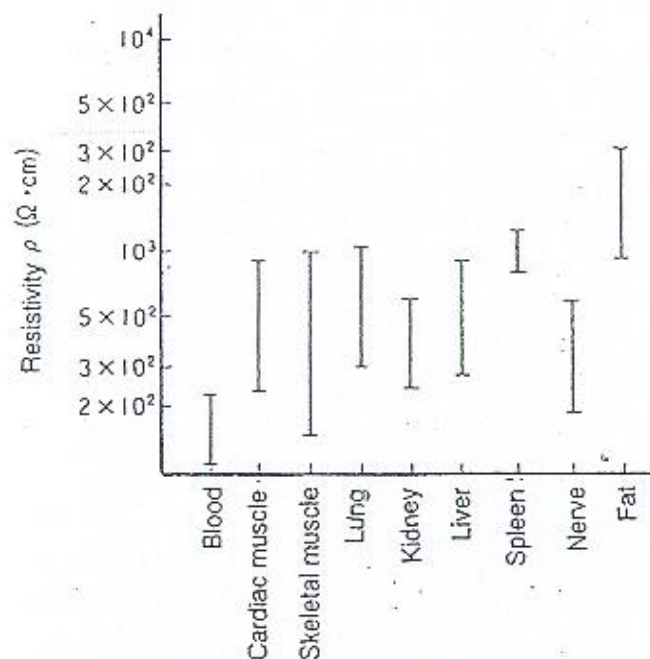

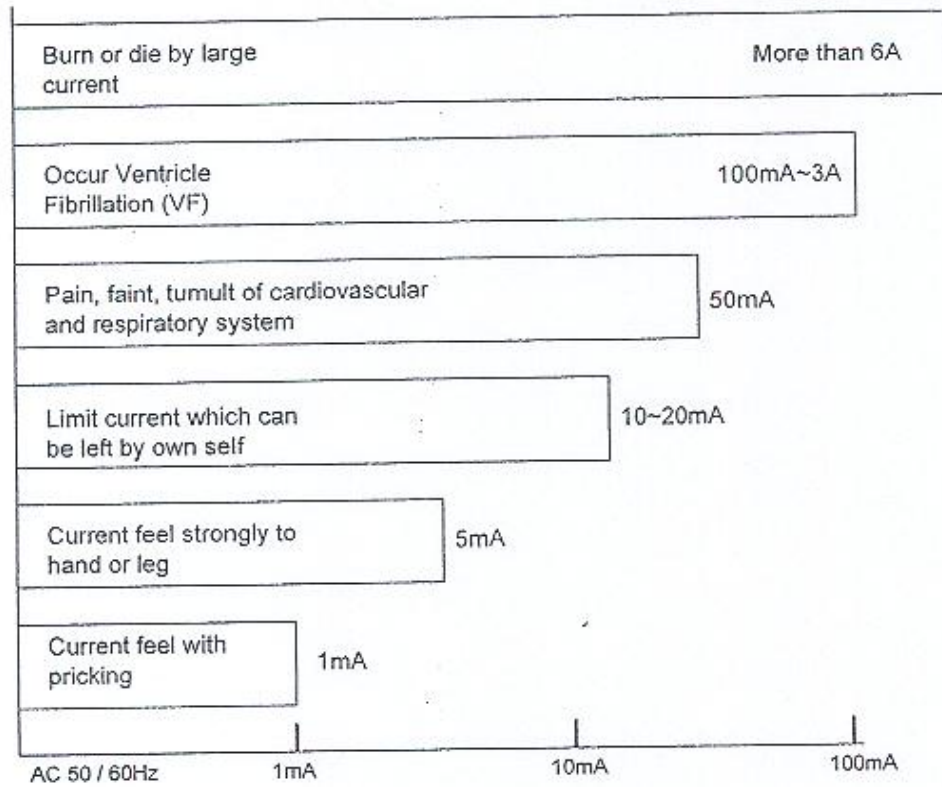

Figure 6. Reaction of human body against Macro-shock

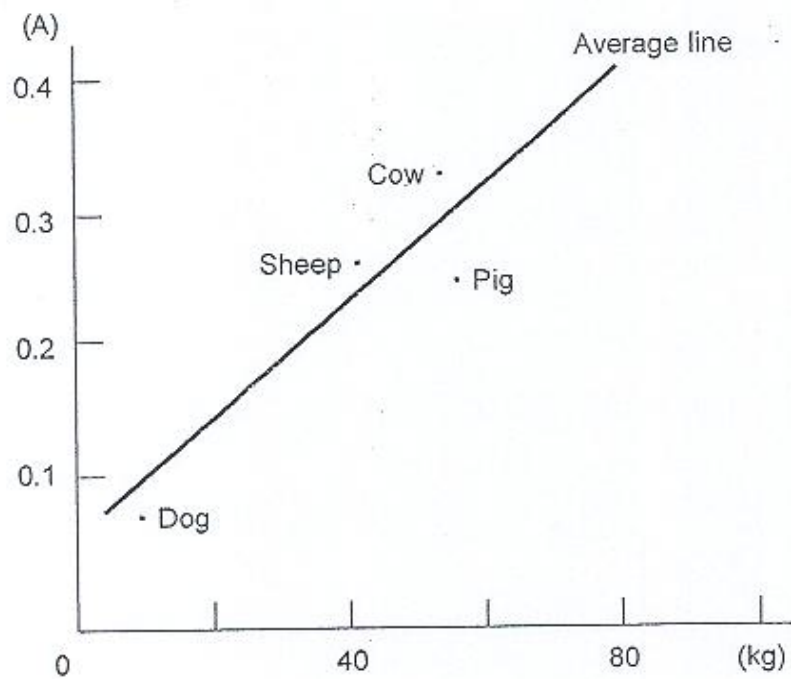

Figure 7. Electric current which is occurred VF against respective animals



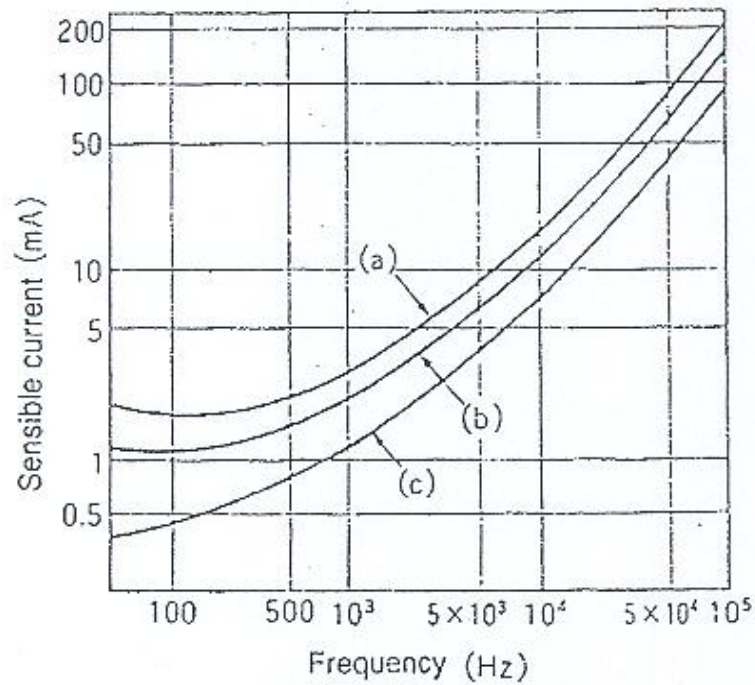

Figure 8 Frequency influences on sensible current

## 6. Mechanical characteristic (Viscosity)

### \* Viscosity

Viscosity is one of the important factors that represent characteristics of substances indicating flow property of body fluid for example.

Viscosity is defined as to relation between the shearing velocity and the stress when the strain is occurred by shearing stress as a resulting from the load. If stress and shearing velocity are linear, and it is not dependent on fluid flow, such fluid is called Newton's fluid. As much as viscosity is high, shearing velocity becomes low against shearing stress, and the fluid becomes hard to flow. Blood is not regarded as a Newton's fluid due to RBC behavior, but platelet is almost treated as Newton's fluid.

Table 7.10 Viscosity of living tissue (cP)

Human Tissue	Viscosity
Water	0.67 (37°C)
Blood	1~6
Soft tissue	0.7 × 10 <sup>8</sup>

## 7. Characteristic against Ultrasound

Mechanical and sound wave vibrations could be represented as characteristic of propagating the wave motion. Wave propagation could generally be classified into 3 types, i.e., longitudinal wave, transversal wave and surface wave. However, it can be said that transversal wave and surface wave of sound wave and ultrasound are remarkably attenuated (See Table 7.11); as a result, mostly longitudinal wave can be propagated. The characteristic of sound wave and ultrasound is the same, and the sound velocity is 340 m/s in the air, and 1500 m/s in soft tissue as same as water. In clinical fields, ultrasounds at the range of 1 – 10 MHz are commonly applied.

*Table 7.11 Ultrasound propagation velocity, characteristic impedance and absorption coefficient of the human body*

Substance	Sound Wave Velocity (m/s)	Characteristic Impedance ( $\times 10^{-6} \text{ kgcm}^{-2}\text{s}^{-1}$ )	Absorption Coefficient $\alpha$ at 1 MHz ( $\text{dB cm}^{-1}$ )
Air (0°C at 760mHg)	331	0.004	12
Blood	1,570	1.61	0.18
Brain	1,541	1.58	0.85
Fat	1,450	1.38	0.63
Kidney	1,561	1.62	1.0
Liver	1,549	1.65	0.94
Muscle	1,585	1.70	1.3 (direction of fiber) 3.3 (crossing direction of fiber)
Cranial bone	4,80	7.80	13
Water	1,480	1.48	0.0022

## 8. Thermal characteristic

### 8.1 Introduction

Most of physical energies, when they are exerted to the living tissue, they are changed to the heat energy. Direct effects to the human tissue are often heats. In the medical sector, it has been noticed since old time that the temperature is one of the important information from the body.

The human body originally produces and radiates the heat, and keeps the body temperature at narrow range of 37 °C even in various temperature environments. However, when a specific temperature (cool or hot) is exerted to a whole body or a part of body, the constancy of the body temperature is often destroyed, causing of systemic hazard. Figure 9 roughly shows the reaction of the human body against the body temperature, causing of the following hazardousness at each range of temperature:



- Sthenia of action of WBC at range of 39~40 °C
- Tetany of protoplasm, death of WBC and change of RBC's shape at around 50 °C
- Hemolyzation at 60 °C
- Blood coagulation at 70°C

If a high temperature exerted to a whole body is continued, adaptive phenomena such as increasing pulse and breath and perspiration occur at first, soon after the body falls into tissue respiratory insufficiency and metabolism insufficiency causing of acidosis because the oxygen bound function of blood is decreased though oxygen consumption is increased.

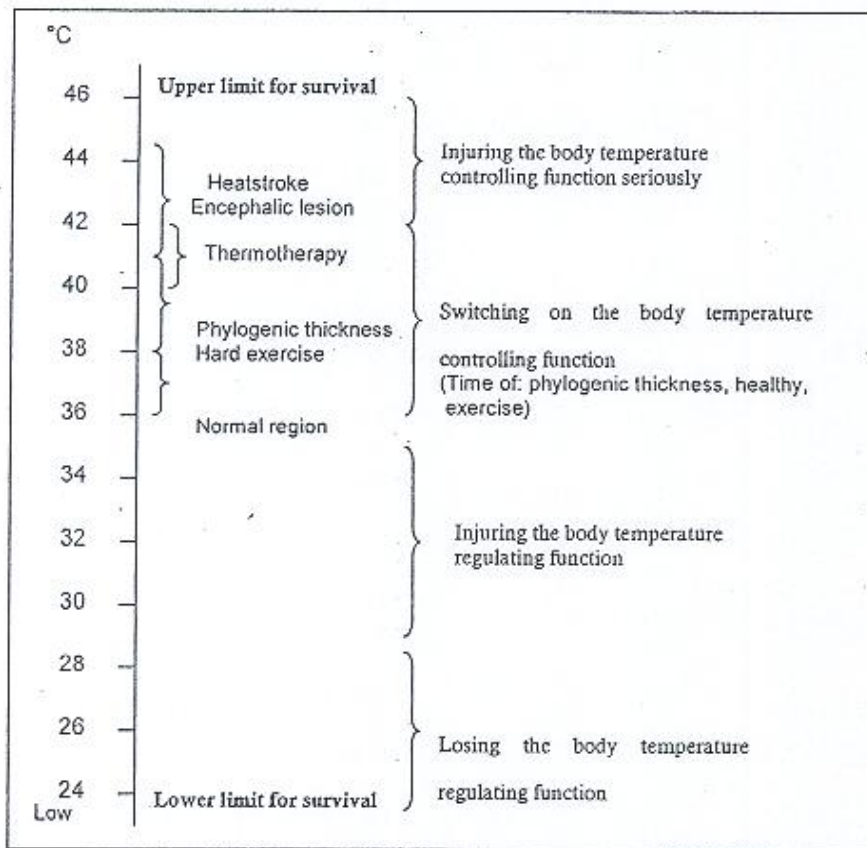

*Figure 9 Causes of body temperature changes and reaction of the human body (From Stolwijk, J.A.J.: Proceedings of the International Symposium on Cancer Therapy by Hyperthermia and Radiation, 1975)*

Moreover, if such situations progress more and more, hypohepatia occurs, bringing come into death. When the heat is exerted to a regional point, the human tissue makes local reaction.

Most typical reaction is to increase peripheral blood flow, carrying away the heat accumulated on the regional point. When a living tissue is exposed under

much higher temperature, the living tissue changes as shown in Figure 10.

On the other hand, when the tissue exposed under low temperatures, the skin suffers from frostbite, bringing rubedo, blister and gangrenous tissue failure. If a whole body is exposed under low temperature atmospheric, the body temperature becomes low and gets into sympathetic hypertonia, bringing fatigue feeling apathetic feeling and hypnotic feeling, and then finally ataxia and blood pigment urine occur.

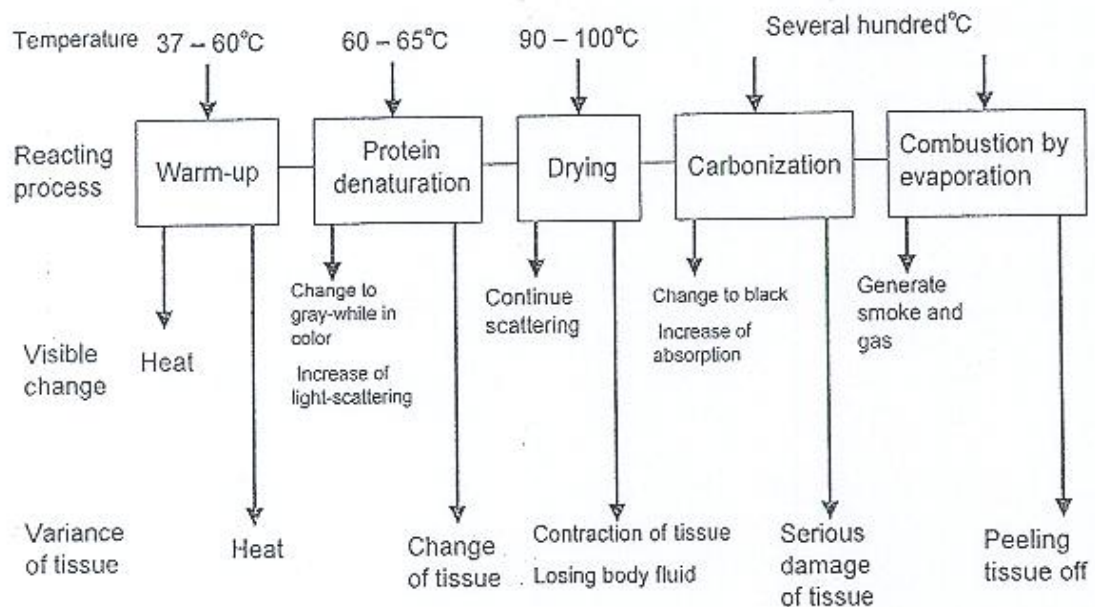

Figure 10. Human tissue changing process under heat-up

## 8.2 Effects and Hazardous Involving Warm-up

Figure 10. shows process of changing living tissue. At the temperature of more than 60 °C, protein denaturation occurs, meaning irreversible change. At less than 60 °C, the effect is dependent on temperature and time. Figure 7.13 shows results that normal tissue and tumor tissue of mouse's inferior limb are soaked into hot water in which temperature and time are given for change. Even normal tissue shows that the inferior limb is falling off caused by hot necrosis in a short time (tens minutes) with the temperature of 45 °C. Tumor tissue easily gets hot necrosis shorter time than that of normal tissue, because the blood control system of the tumor tissue is immature, as a result, the blood flow carrying away the heat is inefficient. From these results, it can be said that tissue at cell level comparatively gets hot necrosis at higher temperature as a border line (threshold) of 42.5 °C. Therefore, Even low temperature that does not give protein denaturation is exerted, cold burn occurs.



Transcutaneous blood gasometry monitor acquires the signal with electrodes applied on the surface of the skin that is warmed up of 42~45 °C. In operation of such equipment using the temperature at more than 43 °C, warm-up temperature at the same point should be less than 2 hours, and if it is operated for long time, the electrode applied part should be changed to another applied part.

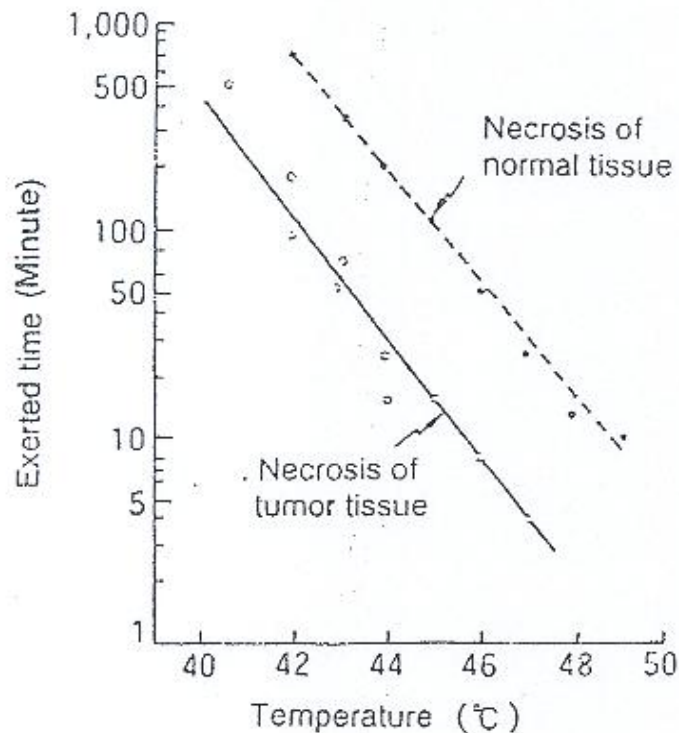

Figure 11. Relation between the temperature that is the same heat effect and the exerted time (From Grile, G: *Cancer Res.* 23:372, 1963)

On the other hand, warm-up effect to the human body also gives medical treatment effects, e.g., effect improving periphery circulation. Such effects, therefore, have been used to improvement of tissue metabolism and of pain.

## 9. Optical characteristic

### 9.1 Introduction

Effects of lights used in medical sector are mainly classified as follows:

- 1) Direct effects exerted by small amount of light energy (e.g., sterilization by ultraviolet rays, phototherapy for infant hyperbilirubinemia);
- 2) Photochemical effects used in Photodynamic Therapy through HpD (e.g., hematoporphyrin delivative);

3) Thermal effects that apply strong LASER.

To consider passive optical characteristic of human tissue, it is individually necessary to understand that of reflection, absorption, scattering, penetration and so on. These basic characteristics are not only peculiar on optical characteristic, but these are also general phenomenon occurred between the human tissue and the all electromagnetic waves including lights (See Figure 12).

Wavelength of light is classified into three regions, i.e., ultraviolet, visible light and infrared. Each wavelength region gives quite different characteristic to the human tissue (See Figure 13.)

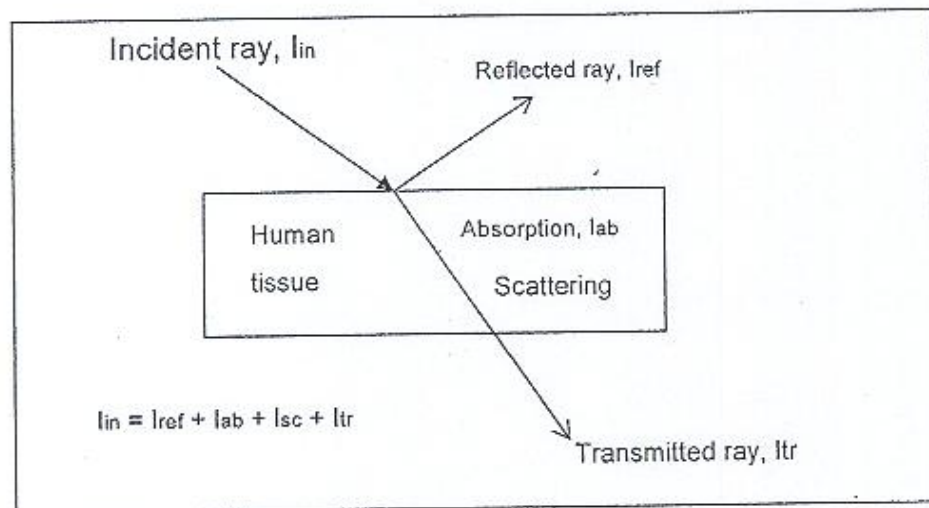

*Figure 12. Light passing through human tissue*



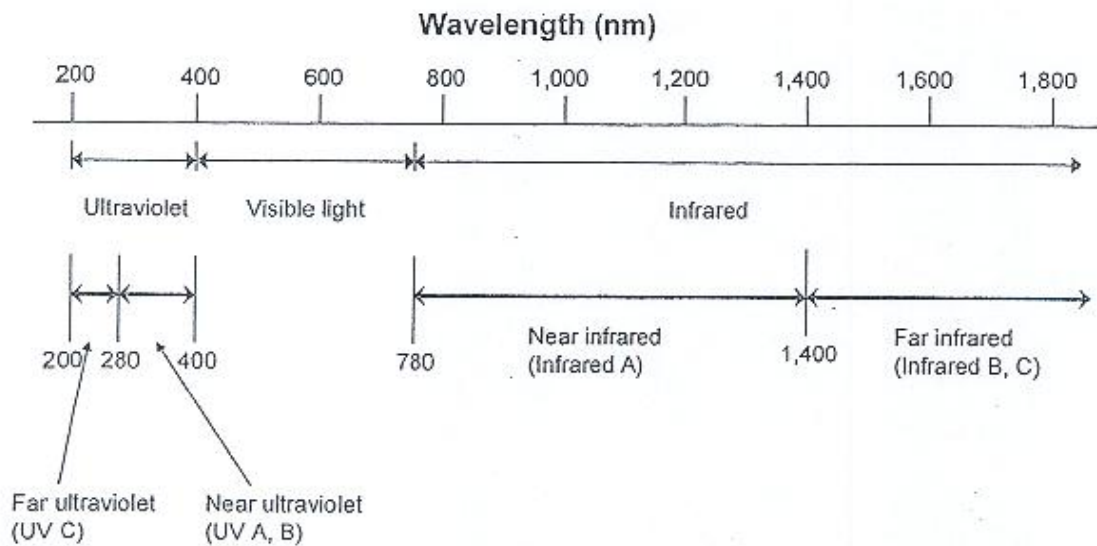

*Figure 13 Wavelength of lights and its classification*

### 9.2 Effects of Ultraviolet to the Human Body

Macromolecule substances inside of the human body well absorb ultraviolet in which is wavelength of less than 200 nm. In general, the human body is easily damaged when the shortest wavelength of the sunlight. The remarkable sterilizing effect of ultraviolet rays, which is wavelength of 253.7 nm, is well known.

### 9.3 Effects of Visible Lights to the Human Body

Substance that indicates most conspicuous absorption within visible light region (range of wavelength 400~780 nm) is hemoglobin inside of the blood. In addition, various organism pigments existing inside of the skin tissue belong to this. The absorbance of hemoglobin is suddenly increased less than at a border of 600 nm as shown in Figure 7.16.

*Figure 14 Optical characteristic of blood and collagen*

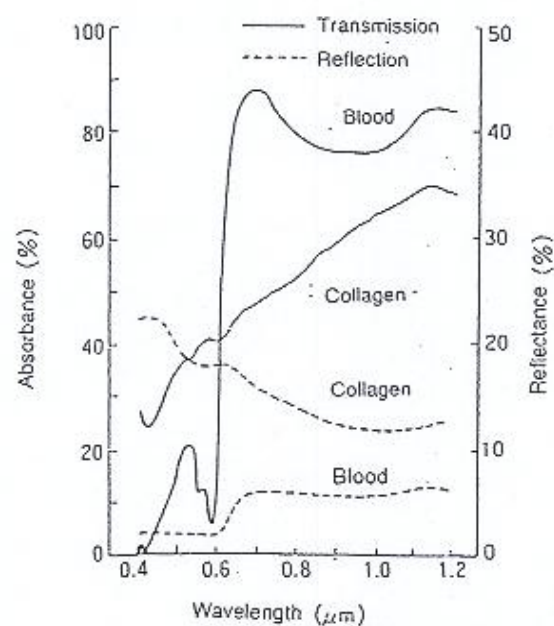

#### 9.4 Effects of Near Infrared to the Human Body

Within infrared lights, the range of wavelength from 780 to 1,400 nm is called near infrared. In this region, as lighting absorption of hemoglobin and moisture is tiniest; the light is well penetrated into the tissue. This means that the absorption is tiny and scattering mainly causes attenuation of the light

#### 9.5 Effects of Far Infrared to the Human Body

The range of wavelength in more than 1,400 nm is called the *far infrared*. Water that is shared in the most human tissue well absorbs far infrared (Far IR). An outline of absorbance characteristic against form UV to Far IR at the human tissue is shown in Figure 7.25. Because wavelength of Far IR is short comparing to UV, the luminous quantum energy decreases. For example, the luminous quantum energy at wavelength of 1.06  $\mu\text{m}$  is of 27 kcal/mol, smaller than dissociation energy of human molecular bond. It only gives effects of vibration, spin and expansion/contraction of molecular bond, producing the heat.

#### 9.6 Requirements for Safety on the Light

Most important requirement for safety on the light is hazardous of eyes and skin. Table 7.13 shows hazardous occurred when excessive light including various kinds of wavelength is exposed to the human body.

Table 7.13 Effects of excessive lights to the human body in each wavelength

Wavelength Region	Eyes	Skin
UV C (200~280 nm)	} Ophthalmia	Rubedo (sunburn)
UV B (280~315 nm)		Increasing Skin Senescence
UV A (315~400 nm)	Cataract caused by photochemical effect	Increasing pigment to be black in colour
Visible Light (400~780 nm)	Damage of retina caused by photochemical and heat effects	} Hotburn
IR A (780~1,400 nm)	Cataract, Damage of retina	
IR B (1.4~3.0 $\mu\text{m}$ )	Hydatoid flare, Cataract, Cornea burn	
IR C (3.0~1.000 $\mu\text{m}$ )	Only cornea burn	



# 8-EVALUATION OF USABILITY FOR THE MEDICAL EQUIPMENT

## 1. Introduction

It sometime happens that failure of medical equipment brings serious effects to human body. This effect is different from other electric equipment such as TV or refrigerator, etc. When these equipments are broken, justly we cannot watch it and foods cannot refrigerate, but only become just inconvenient for our life. However, it wouldn't be affected significant crisis to human body. In case of medical equipment, it is different situation occur. If medical equipment, especially the equipment that should be connected with human body directory (for example: respirator, ECG, hemo-dialysis, etc) have a failure or break down, it will be possible to bring death in the worst case. To avoid this situation, it is necessary to understand correct way to use and appropriate way of maintenance. Therefore, the role of technician is very important.

If appropriate maintenance is implemented, the medical equipment always works property. It means medical staff can provide proper diagnosis and treatment, as a result, patient will be able to obtain best service from the hospital. If you can maintain this situation for long time, you can get certain reliance among patients, operators, and technicians.

In this chapter, we try to learn how to improve the reliability and what is reliability of medical equipment.

Even excellent engineers maintain medical equipment properly; it will be broken someday. Medical equipment has life period as well as human body. Trying to extend their life period is one of important role of technician; however it is difficult to survive for twenty or thirty years and more.

Even the equipments are used under the proper environment, for long term use, they will become deteriorate and obsolete. And it will be appeared break down and failure. When the rate of failure is increasing, a part of the safety hazard, it will occur serious obstacle as well as a part of economy, the cost of repair is increasing. Overall, the efficiency of using equipments is become worse because of these reasons. When medical equipments are in this situation, it can be said this equipment is died.

The judgments of equipments' death are also important role of technicians. Technicians are always appropriate judgments from the aspects of reliability.

Regarding reliability, it will show simple example in following section.

## 2. Which reliance will you choose?

Example: Airplane

When you go to Thailand, you have to use airplane. To go to Thailand, there are two type of airplanes are used. One airplane is used two engines (hereafter by A2), and the other airplane has four engines (hereafter by A4). Both of them are same price and services. Which airplane will you use?



Figure 1: 4 (four) engines airplane



Figure 2: 2 (two) engines airplane

To consider simpler, we will make hypothesis.

- 1) The probability of failure is equal
- 2) If one of engines are worked, it never crash
- 3) If one of engines are broken, the schedule will be delay
- 4) Other condition of these airplane is same

Which will you choose?

The scariest event of airplane is crash. At first, we calculate probability of crashing of both airplanes.

We will use the symbol "P" as the probability of breaking one engine. According to hypothesis 2, A2 will crash its two engines are broken. And the case of A4, all four engines are broken it will crash. The probabilities are

$$\text{Probability of crashing A2} = P^2$$

$$\text{Probability of crashing A4} = P^4$$



Recently, the reliability of aircraft engine is high, so that probability of crashing cause of engine itself are about  $10^{-4}$ ~ $10^{-5}$ . Therefore, the answer is clear.

Overall, the reliability becomes higher when the probability of break down is less under designing of machine. The case of medical equipment, it is not necessary serious reliability same as aircraft. However, we have to remember the failure of medical equipment also bring serious danger for our life.

To understand this fact, we have to learn how to evaluate reliance by quantitative way. We will show several methods and ways, so please refer these skills.

### 3. Concept of safety system

#### 1) System

At present, several kinds of medical staff care patients in surrounding intertwine with a lot of medical equipment, computer, electronics, and facilities. We call "System" the situations such as lots of elements are consisted.

#### 2) Safety System

It cannot achieve total safety by individual efforts into the system. The important point is to check and observe total system and how each element is connected. Then it should make safety plan for each case.

#### 3) Definitions of safety system on ME

The definition of safety system on ME is; "to make countermeasures for fulfillment of reaching the most safety condition in all life cycle stages under limited condition such as equipment, system, facilities, environments, materials and economics."

**Table 1. Safety measures on human engineering towards equipment**

a. Structure without any disorder occurred	b. Consideration and design on aspect of human engineering
① Solidity structure which will not occur any essential disorder	① Interface for matching characteristic of human
② Detect of disorder sign	② Standardize of location and position (control and connector)
③ Remove condition which brings worse situation	③ Standardize and aptitude of operation order
④ Minimize for danger disorder	④ Adoption of coding (unity of shape and color)
⑤ Prevent for expansion of disorder	⑤ Accord with direction of operation and function changing
⑥ Function of recovering normal condition	⑥ Indicate of information in order
⑦ Exchange function	
⑧ Indicate of disorder situation	
⑨ Prevent disorder situation	

#### 4. Safety measures on human engineering

There is nobody who never does error. Basis of this human character "Safety measures on human engineering" is consisted. This idea means eliminate cause of human error and adopt safety measurements system in designing of device and equipment surrounding our life. Especially, medical equipments are sought to accept this system more strongly. It will show the detail of this system as following.

##### a. Design and produce of equipment without any disorder occurred

It is necessary to equip structure, function and consist, which we showed on left box in Table 1. There are several systems to prevent human error by function of equipment. Following example are some of them.

- Fail Safe □ + □ Ex.) Cut off the output of Electro surgical unit when the negative electrode (Earth plate is broken)
- Fool Proof □ + □ + □ Ex.) Pin index system of medical gas
- Multiple system □ + □ Ex.) Power supply devise system of Defibrillator (it can use both AC and battery)
- Alarm system □ + □ Ex.) Monitor alarm of cardiograph



Figure 1. Electro Surgical Unit

Example of Fail safe

Patient plate connector

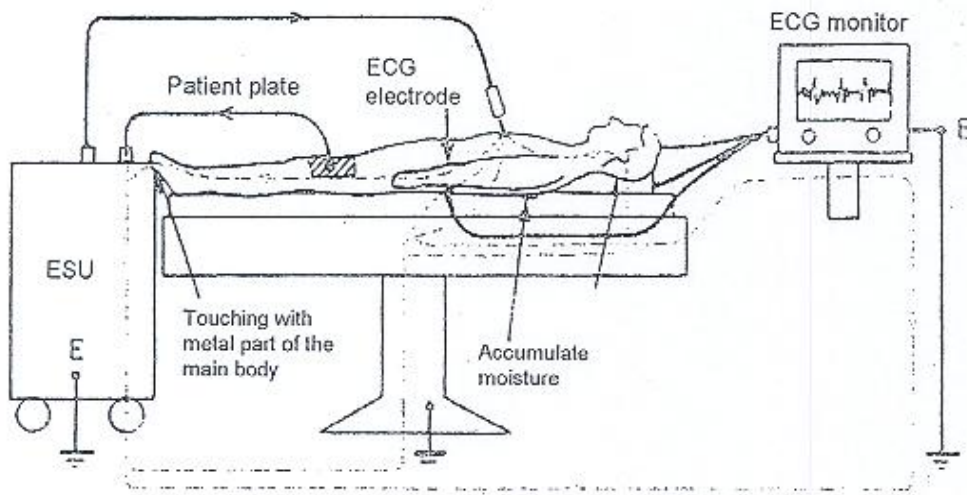
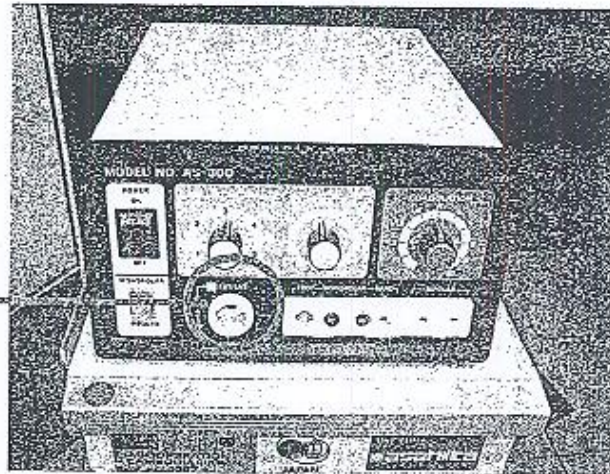

Figure 2. Electro Surgical Unit connect with patient

Example of Fool Proof

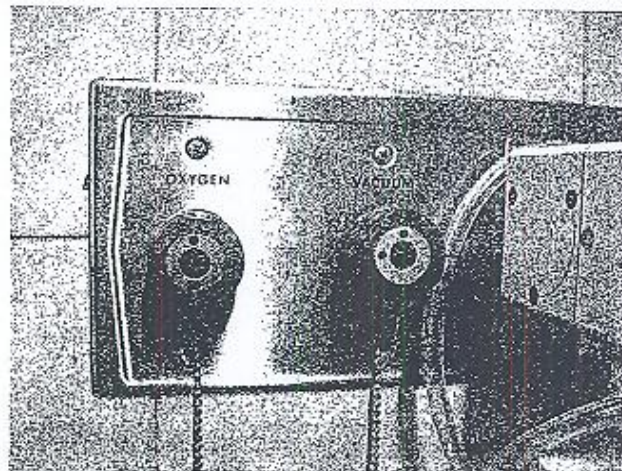

Figure 3. Pin Index system Medical Gas

b. Adopt aspects of human engineering on design and procedure of operation  
 It is important to make standardize of location, procedure, and indicator in order to prevention of simple error under consideration of characteristic of human regarding contents of right box of **Table 1**.

**Table2 The criterion of reliability by aspects of probability**

Criterion of reliability	Symbol	Definition / Meaning
Reliability	R	The probability to implement proper function during certain term under prescript conditions such as types, equipment and parts
Maintainability	M	The probability to complete maintenance under certain conditions such as prescript types, equipments, parts within restrict time
Availability	A	The probability to preserve the possibility of repair types, equipments, parts within certain term

## 5. Methods of safety system

### a. Procedure

To examine and implement safety system as following order. (Feed back system)

- 1) To collect detail information of trouble
- 2) To analyze causes of trouble by classification of each types
- 3) To classify of emergency level by level of seriousness
- 4) To decide priority of implementation basis on examination of considerable countermeasures
- 5) To implement each countermeasures by following examination
- 6) To do feedback to reconsider effects of each countermeasures

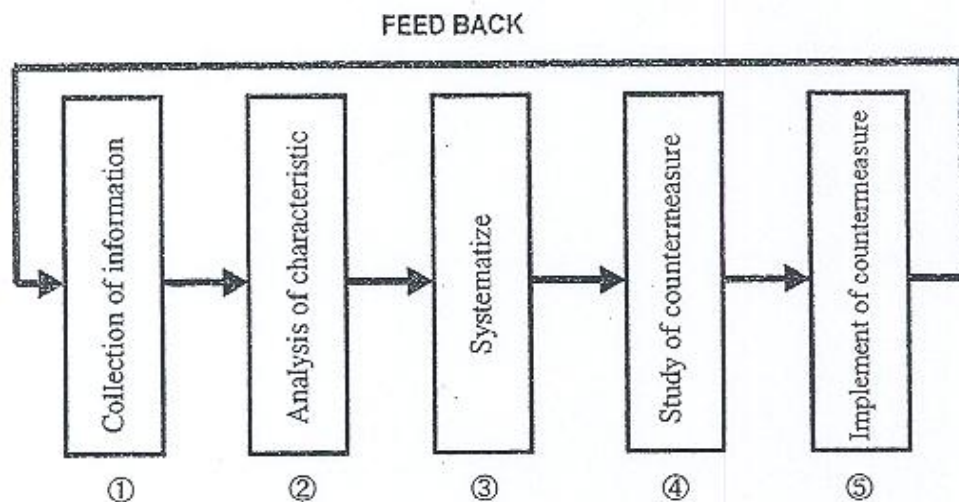

**Figure 4. Processing of safety system by Feed Back**



**b. Analysis Method of characteristics**

In order to analysis for causes of troubles, the methods of FTA and FMEA are used.

1) FTA (Fault Tree Analysis) (Figure 5)

It is the methods to analyze whole causes by investigation the each case of trouble. In order to analysis, it describes each phenomenon by AND Gate and OR gate. Also it can analyze probability of trouble by using quantity date.

Figure 5. Example of FTA (Fault Tree Analysis)

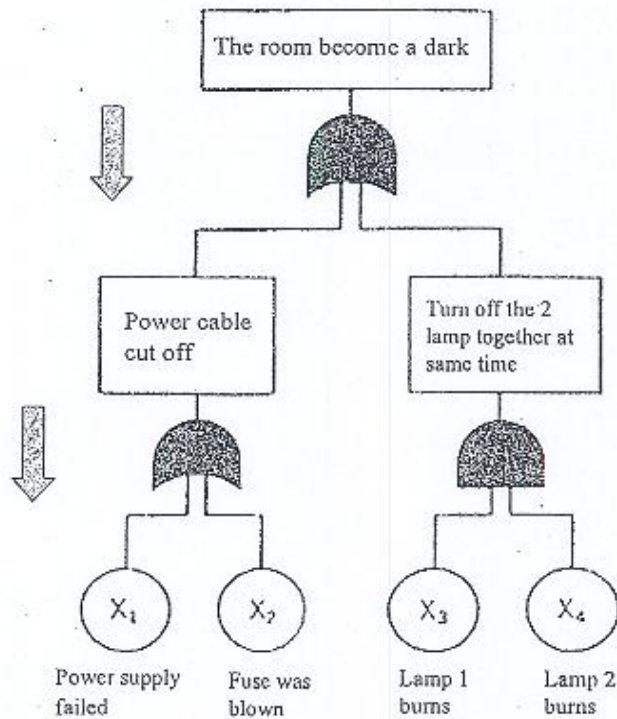

2) FMEA(Failure Mode Effect Analysis) (Table 3)

It is the methods to analyze and examine the effect how each case relates total phenomenon by chart style. It is useful to grasp total phenomenon.

Table 3. Example of FMEA (Failure Mode Effect Analysis)

Part	Time	Failure or accident	Effect or influence	Level	Measure
Ground	Under examination	Trip and electric shock	Macro shock	Crisis	Need to study how to connect
Earth plate	Under operation	Contact failure	Burn	Crisis	Need to study how to fix

To analyze following procedure:

- Define accident or failure
- Draw the structure diagram of the system and clarify correlation with the function of each element.
- List up the part of accident cause effect to the system.
- Analyze that failure and accident cause effect to the system.
- Investigate the frequency of failure or accident.
- Consider the adequate measure against problem

## 6. Criterion of reliability

### 1) Series system / Parallel system

To minimize of probabilities on failure occasion regarding medical equipment, it is necessary to create systems and circuits to avoid serious trouble when any failures happened. Chart 4 shows the theory for possibilities to exchange series and parallel system under designing condition.

This chart shows the series system is less reliance compare with parallel system. It is clear that the parallel system is more reliance

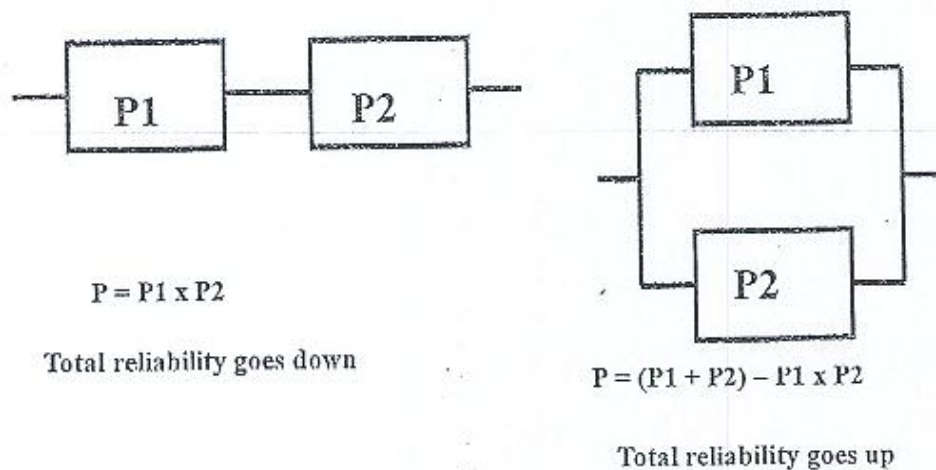

P : Probability which is failure and less than 1

Figure 6. Reliability of the series system and parallel system



2) Calculate for average operation term

a. MTBF (Mean Time Between Failures)

The mean time of non-failure term between one failures and other failures (the average available action time)

b. MTTR (Mean Time To Repair)

The mean time of repairing (the average unavailable action time)

c. AVAILABILITY

The time of availability / (available action time + unavailable action time)

$$A = \text{MTBF} / (\text{MTBF} + \text{MTTR})$$

It means this formula show rate of operation of equipment

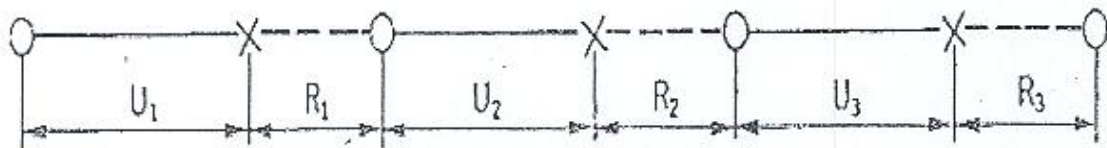

Figure 7. Concept of MTBF, MTTR

Please evaluate reliability of medical equipment in your hospital by using these methods regarding reliability engineering.

If you can evaluate reliability by using quantitative methods, it will be able to avoid the situation that failure equipment accumulates like a junk storage.

## 9-LESSON LEARNED ON ME MAINTENANCE FROM NMCHC

### - Definition of Bio- medical equipment

Equipment used for diagnosis and treatment at a clinical site is called medical equipment. In fact, the term <Biomedical equipment> is now being used widely in the world.

Biomedical engineering is the integration of **M** (Medical science) and **E** (Engineering Science) as shown in figure below. Research in the field of medical Science develops into Biomedical Engineering, and the research in the field of engineering science develops into Medical engineering. As a result of, uniting the two, the study became a system called Bio-medical engineering.

Therefore, equipment used at clinical site is called biomedical equipment. The bio-medical equipment is developed based on biomedical engineering technology. A person who trained in medical and engineering field, work between medical equipment and patients is called Clinical Engineer.

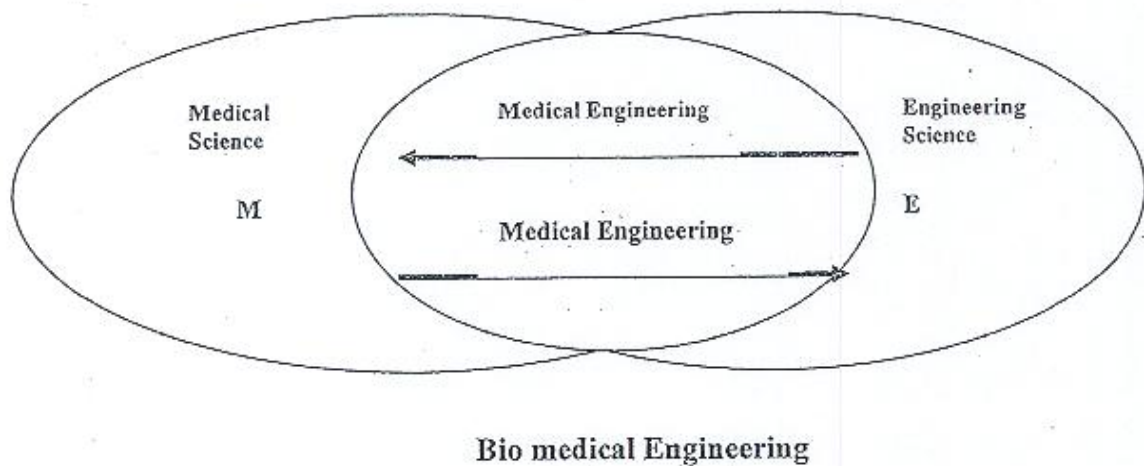

### A Definition of Bio-medical Equipment

#### - Background of ME Maintenance Staff

This factor is very important to make decision of the maintenance level with job descriptions as well as contracting out services.

ME maintenance staff should have clinical background, be trained on maintenance and be able to observe the performance and safety of respective equipment. In addition to this, he/she could be of assistance to maintenance management of medical equipment in the hospital.



## - Maintenance Policy

### 1. Introduction

With the introduction of medical equipment in many fields of activity, it is considered essential that the organizations should have sound policy for the maintenance of medical equipment and ensure the continuity of service from the same.

However, a question does arise in one's mind as to "why is the necessary of inspection, change of components and preventive maintenance of an equipment working normal? It is enough to repair the equipment when it becomes out of order". This philosophy is not correct particularly in the case of sophisticated hospital equipment that involves in high technology.

The basic concept of the maintenance policy is to support the life and health of patient with keeping the *reliability and safety* of the equipment operated daily at the hospital. Remember that the efficiency and quality of health care service in the hospital depends on the accurate and hazard free functioning of equipment. Use of malfunctioning of equipment can obviously lead to serious harm to patients resulting even into death in some instances. To keep the reliability and safety of the equipment, overall factors such as management, finance, technical matters and environmental conditions based on the philosophy of medical services should systematically be combined as one.

### 2. Importance of Maintenance

A large number of medical equipment that applies a highly advanced technology has been operated in large establishment of hospitals for diagnostic and therapeutic purposes. Such medical equipment has to work with keeping the reliability and safety. Reliability means that the equipment shall be perfectly accomplished with its supposed diagnostic/ therapeutic functions and purposes. Safety means that the equipment shall be operated without any risk of life of patient, operator and surroundings.

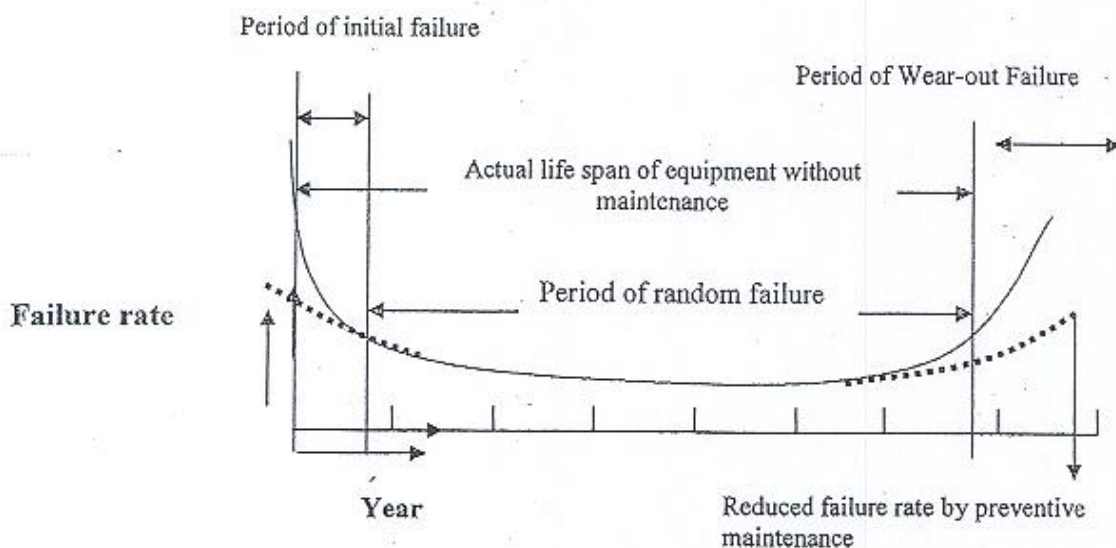

Figure 1: Bathtub curve showing the failure rate occurred during life cycle of equipment without preventive maintenance. Since preventive maintenance is carried out,

*the failure rate could be reduced. This failure rate, however, occurs only on main body of equipment, but failures of accessories and consumable are not considered.*

Reliability and safety are closely related to each other and are important in order to consider the procedures for development, design, recognition, manufacturing, sale, shipment and clinical operation of the equipment.

The equipment dispatched to the user would gradually lose its performance and safety with the passage of time; also the equipment failure rate would increase following the *Bathtub Curve* as shown in Figure 2. It means that reliability and safety of the equipment decrease in effectiveness relation to confidence of clinical operation.

From the above discussion, it is necessary to point out a "maintenance and safe management" program by giving legal instructions regarding regular inspection of all types of medical equipment in order to keep the reliability and safety in the hospital.

If equipment is not well maintained, the equipment failure curve becomes curve ABF (see figure below). This means the effective life span becomes shorter. This cause is clear.

Most medical equipment is composed of the actual equipment (main body) consumable (eg: filter, recording paper, and regents), consumable components (eg: lamp, motor, brushed and sensor), and accessory (eg: probe, patent cable, and electrodes). However, except for the consumable and accessory is about 2-3 years. With deterioration of these, the functioning of equipment is impaired and often breaks down. As a result, the failure rate increases sharply 2-3 years after installation.

Still, the equipment may break down without noticing the malfunction even though the equipment seems to be normal. For instance, the wear out of motor brush of a centrifuge is a typical example. The life span if the motor brush is about 2-3 years in normal use. However, if the equipment is continuously use with the motor brushed worn out, the contact surface of the motor (accumulator) that comes in contact with the brushed will be destroyed, and an irreparable breakdown follows.

To avoid the above mentioned problem, it is essential to perform regular inspection and supply/ replacement of accessories and consumable components from the time of installation.



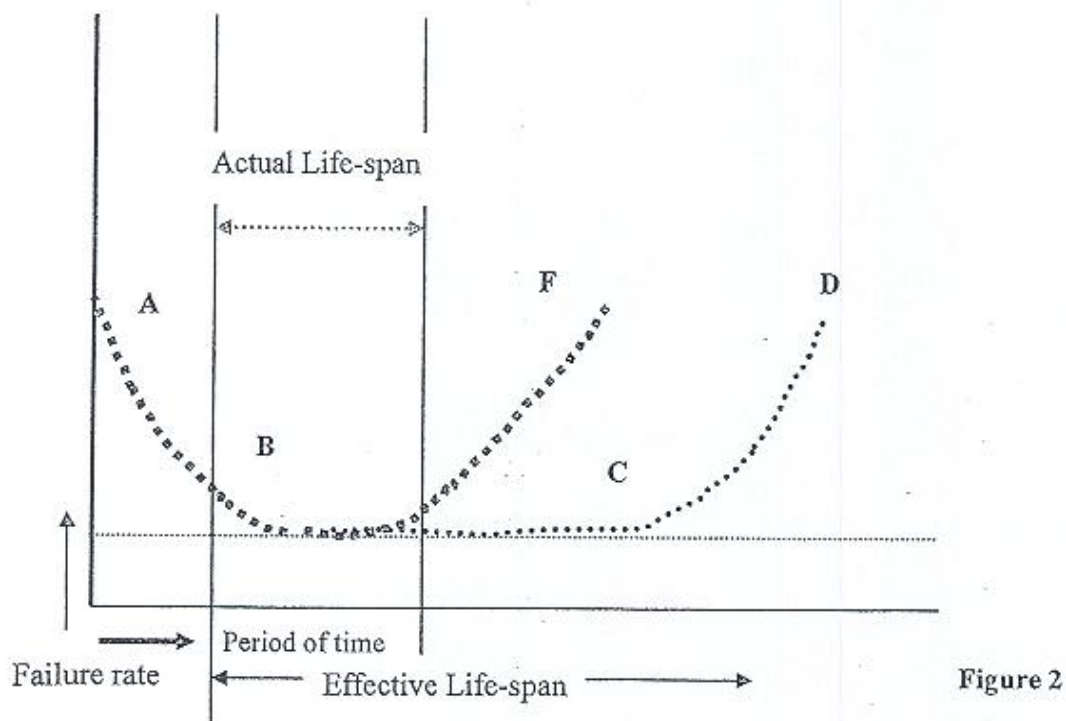

Figure 2: This figure shows the different curve from figure 1. It shows the failure rate in a life cycle of medical equipments without preventive maintenance. Since preventive maintenance is carried out, the failure rate could be reduced. This failure rate, however, occurs only on main body of equipment equipped with accessories and consumable.

### 3. Importance of in-house service

Usually, reputed manufacturers of medical equipment offer efficient and effective after sales service; generally, their representatives carry out such services. This could be classified as follows:

- a) Breakdown service which is provided on call when the equipment breaks down and faults to function satisfactory;
- b) Contract service under which contract terms are agreed upon by the supplier/local agent of the equipment and the user for preventive as well as for corrective maintenance service.

Large establishments and medical institutions cannot depend solely on the service offered by manufacturers. More often such services tend to be expensive and may not be available when needed during emergency breakdown of the equipment. It is, therefore, necessary to strengthen in-house repair and maintenance system by the authorities.

In such situations, simple and routine faults could be immediately attended to in-house and only in the event of a highly complex fault; the services of the manufacturers are requested for. In addition, as the in-house service system is in existence, the

reliability and safety of the equipment operated at the hospital could systematically be evaluated.

#### 4. Consideration for the Life Span According to the Life Cycle of Equipment

Sophisticated devices used in aircraft and railway transportation industries for example have been operated for a long period. In those industries, regular inspection and preventive/ corrective maintenance carried out under Legislative Act are playing to keep these sophisticated devices operation for 20 or 30 years.

The medical equipment also might be operated for a long time as far as possible since installation. Sophisticated equipment in daily operation, ECG equipment for example, could be used for more than 10 years if it would completely maintained while the life span of the equipment is generally said that is five to six years in accordance with the depreciation. Thus, the life span of such equipment could be kept for a long time than that of consideration in general, but it certainly becomes unserviceable. Finally, it would be condemned.

In general, the following factors may be discussed to determine the condemnation of the equipment:

- a) Finance and refund;
- b) Depreciation;
- c) Required clinical level;
- d) Availability of spare parts and consumable;
- e) Reliability and safety.

Here, we shall try to consider the expected life span of the equipment according to the life cycle of equipment from the technical viewpoints.

Figure 3.2 shows the relation between the life span and life cycle of the equipment based on Figure 3.1. In case of operation without the maintenance, a term of initial failure<sup>(1)</sup> may be 1 year<sup>NOTE)</sup> and random failure 5 or 6 years, though the life span of the equipment depends upon the number of operation hours, environmental conditions, handling technique and so on. It must be remembered that the above-mentioned life span is only for *Main Body* of the equipment.

The maintenance of equipment should be carried out even after installation, and continue it during period of random failure. The operator also should perform preventive maintenance at least cleaning up the equipment and replacing consumable components. If those are not carried out, life span of general medical equipment (e.g., patient monitors, ECG equipment) may be 6 or 7 years, but in fact, why such equipment often becomes inoperative or defective 2 or 3 years after installation? This is because that life span of main body is 6 or 7 years, but life span of accessories or consumable components (e.g., patient lead and pulse sensor along with the equipment) is just 2 or 3 years. For this



*NOTE: In fact, the user may not detect such defects because such shortcomings are often observed and rectified during examinations/inspections after manufacturing in the factory or at the installation stage.*

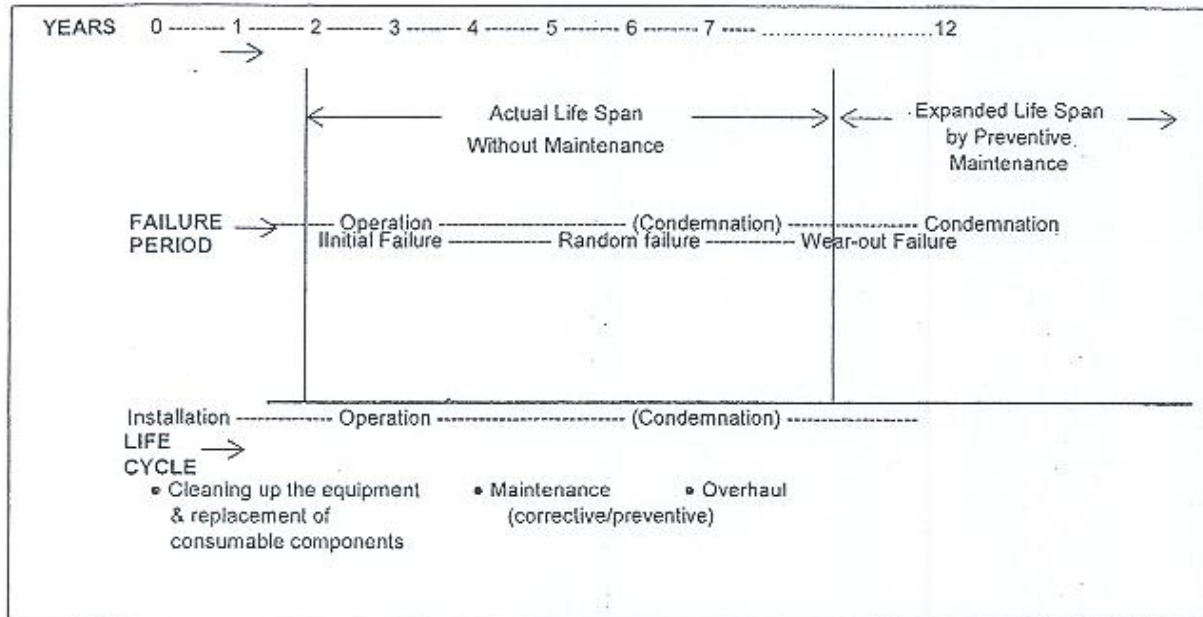

Figure 3 Relation between life cycle and life span of equipment.

For this reason, some other type equipment that need replacement of various kinds of consumable components (c.g., anesthesia apparatuses, high pressure steam sterilizers) may also become inoperative or defective 2 or 3 years only after installation without maintenance.

Without carrying out the maintenance, the general medical equipment would face a risk of failure 6 or 7 years after installation as mentioned the above. In this case, the equipment is considered to be condemned. On the other hand, if the corrective/preventive maintenance have done continuously since installation, the failure rate would become down and the life span of the equipment could be expanded more than that of the life span without maintenance; it may be 1.5 times or even 2 times of actual life span. In addition, the failure rate could be reduced and the life span also be expanded as "overhaul" is carried out.

When many failures appear at a time or failures appear repeatedly, the budget expenditure on repairs increases and equipment's reliability and safety could not be kept anymore, that indicates the end of equipment's life. As the next step, the condemnation of the equipment (throw away matter) may be discussed by using many-sided data on the clinical field, medical engineering and finance. From the point of view of the medical engineering, a guideline to estimate the condemnation of the equipment is as given below:

- A- From viewpoints of safety: the data which estimates the safety of the equipment, e.g., leakage currents and patient leakage currents, isolation resistance, and X-ray/radioactive protection.
- B- From viewpoints of reliability: ensure against quantity, reproductively and stability of performance/functions of the equipment, e.g., measured data, picture, output.

All the above should scientifically and systematically be considered combining with other factors as mentioned on a), b), c) and d). The record of maintenance, repairs and service history of equipment is, therefore, very important as a future reference.

## 5. Factors Determining the Maintenance Policy

The maintenance policy applicable to a particular situation will obviously depend upon several factors. Some of these factors, which are applicable to any hospitals, are as follows:

### A. Quantity of Equipment

Survey that the number of medical equipment which should regularly be maintained.

### B. Type, Group and Complexity of the Equipment or the System

Survey the following items:

B-1 Manufacturer/Model: E.g. ACOMA, FUKUDA, NAKAMURA, .....

B-2 Class: This can be classified into three categories according to the type of protection against electrical shock, i.e., Class I, Class II and internally powered equipment.

B-3 Type: This can be classified into three categories according to the degree of protection against electrical shock, i.e., Types B, BF and CF equipment.

B-4 Group: The medical equipment has been grouped according to the performance required in respect of quality, safety and reliability. As per the national directives of some of the European countries the equipment are grouped in four, i.e., life supporting equipment, active implant equipment, other active device and medical devices without energy.

B-5 Complexity <sup>NOTE</sup>: The complexity of equipment installed in the hospital various some very simple to some complex equipment as given below:



*NOTE: However, the medical equipment could not be categorized only in accordance with the complexity in viewpoints of the maintenance. Because the type of medical equipment depends on diagnostic and therapeutic purposes, Suction Unit for example, this type of equipment is categorized in simple equipment but this is one of the life support equipment. The maintenance without consideration of infection as well as accuracy of vacuum volume gives serious harm to the patient. From viewpoints of the maintenance in medical engineering, classification of the medical equipment are generally as follows:*

<b>Type of Equipment</b>	<b>Typical Equipment</b>
Mechanical Equipment	Steam sterilizers, Suction units, Incubators, Medical refrigerators, Rehabilitation machines, etc.
General Equipment	CTG monitors, Doppler fetus detectors, Endoscopic equipment, ECGs, EEGs, EMGs, Polygraphs, Nebulizers, etc.
Life Support Equipment	Patient monitoring systems, Anaesthesia apparatuses, Electro-surgical units, Defibrillators, Ventilators, etc.
Energizing Equipment	Echo machines, Medical X-ray apparatuses, Cine-angio equipment, CTs, MRIs, LASER units, etc.
Laboratory Equipment	Spectrophotometers, Bilirubin meters, Flame photometers, Blood cell counters, Centrifuges, etc.

- Simple equipment: e.g., Touch mixer, Shaker, Suction unit.
- Simple, but with computer controlled circuits or complicated electronic circuits, e.g., Autoclave, Water bath, ECG machine .....
- Simple, yet with precision mechanism, e.g., Microscope, Centrifuge, Spectrophotometer .....
- Precision and sophisticated equipment, e.g., Fetal Actocardiograph, Medical X-ray apparatus, Mobile X-ray apparatus, Ultrasound diagnostic equipment .....

### **C. Locations of the Equipment or the System**

It will let us know where, how many places, and department the equipment has been installed for operation.

### **D. Operating Conditions**

In general, doctors and nurses at the hospital operate most of the equipment. Wherever necessary they are provided appropriate training at the time of installation of the equipment. Survey that status of operating equipment as follows:

D-1 Handling of equipment:

Equipment must be operated constantly and properly.

D-2 Carrying out user's maintenance:

The maintenance has been effectively carried out at every ward under the responsibility of operator.

## **E. Environmental condition**

In Cambodia, most medical equipment has suffered by inappropriate environment condition, such as unstable current, non-quality water, dust and dirt, atmosphere- high moisture, and many other factors. In Phnom Penh city, the environment condition is better than the rural or country side, but it still has a problem.

To protect to the improper environment condition, some counter-measures should be performed:

### **E-1 Fluctuation of power supply voltage:**

The nominal voltage is 220V. To prevent the equipment failures just in case of resulting from poor quality of power source, voltage regulators are connected with sophisticated equipment such as: Patient Monitor, ECG machine, Ultrasound Diagnostic Equipment and X-ray machine.

### **E-2 Water quality:**

At present, poor water quality affects the condition of equipment having water circuits (e.g., water distiller, ice cube making machine, high pressure steam sterilizer). To avoid this problem, water treatment plant should be equipped to acquire a better quality of water.

### **E-3 Dust and dirt:**

At present, air contains many dusts and they accumulated inside as well as outside of the equipment. Therefore, proper room setting and cleaning outside of the equipment could be just a part of solutions. However, dust which gradually accumulated inside of the equipment will seriously affect to its functions. Thus, dust or dirt should be removed from the equipment twice or thrice a year, or more frequently for some equipment. Remember that, removal of dust from inside of the equipment must be performed by medical equipment technician.

## **F. Expected Calibration Frequency**

The equipment should frequently be calibrated according to manufacturer's instructions and clinical importance rate. For example, performance and safety of the following equipment (*life-support equipment*) should frequently be checked by technical personnel or clinical engineers at least once every three months, and then they should be calibrated if necessary:

- 1- Anesthesia apparatuses;
- 2- Defibrillators;
- 3- Infusion pumps;
- 4- Vacuum machine.

## **G. Preventive maintenance requirements**

The medical equipment becomes fault with the passage of time resulting from the degradation, wear-out and/or breakdown of its components. This status is called



the "wear-out failure". Normally, the number of years, which it reaches, is may be 5 to 6 years. However, wear-out failures could be avoided by carrying out the preventive maintenance.

As the first step of preventive maintenance is that clean up the equipment at inside and outside. The operator should daily or frequently take care of equipment cleaning up enclosure and applied parts of the equipment. Such simple maintenance prevents the failure of the equipment and also keeps the expected life span of equipment.

#### **H. Availability of Spare parts**

One of the biggest difficulties in maintaining the medical equipment in developing countries is the procurement of spare parts. Some general parts/components such as ICs, transistors, diodes, resistors, capacitors, etc., are available in Phnom Penh. However, they slightly help only for minor repairs and maintenance of medical equipment, but not for routine maintenance and repairs.

On the other hand, only a few companies that can offer technical services for medical equipment exist in Cambodia, and they do not keep necessary spare parts except spare parts used in contracting out services. In other words, routine import system for spare parts is not available. For this reason, only a few types of spare parts could be imported from foreign countries for providing the equipment user in Cambodia. This issue is one of the considerations of making maintenance policy.

#### **I. Availability of after sale service**

Only a few companies that can offer technical services for medical equipment exist in Cambodia as mentioned in section H. There is enough numbers of companies dealing with the medical equipment in Cambodia market. However, they cannot offer professionally after sales services to users.

# 10-BASIC COMPUTER OPERATION

In the 21<sup>st</sup> century people around the world are knew well about computer. The computer technology is developing very fast but until now the computer was passed of many versions.

## I. History of Computer

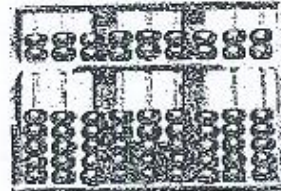
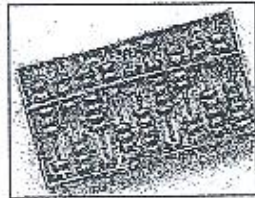

In former time the history of computer come from Chinese calculation, 600 year BC the people use symbol to represent the number, sum, and subtract very fast and correctly. Up to 20<sup>th</sup> century a lot scholars researched and produced many computers such as:

- First generation (1959-1963): Computer used punch card and magnetic tap to input and out put data that the kind of "Large-Scale Electronic Computer". It had big size by using memory of Vacum tubes combination such as ENIAC (Electronic Numeric Integrator and Computer) was produced by J.Presper E Chert and John Mauchly Professors that has length 80 feet and width 18 feet of using 18,000 Vacum tubes to do the calculation.

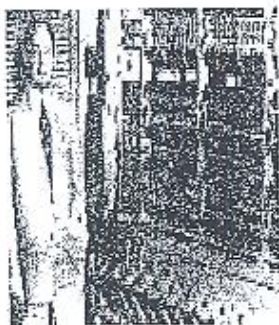

- Second generation (1964-1970): In early 60, transistor was found and had used to instead of Vacum tubes. During that time the computer size become smaller and faster then first the generation of ( $10^4$  to  $10^5$  per second).
- Third generation (1971-1980): During that time the new technology of IC (Integrated Circuit) was created, which can generate Transistors to smaller and store only one chip that use to instead of using transistors computer. IC was used to produce CPU that increase computer capacity



faster, memory was increase to many MB and the process was increase from  $10^6$  to  $10^7$  per second. In this generation, we can make texts and graphs by the computer; especially it can run multi-programs (it can run many programs at the same time). There are Operating systems (OS) and other applications were created and the size of the computer becomes smaller.

- Fourth generation (1981-Now): Personal computer was created by IBM in 1981, which is use 8088 processor and 64 MB of memory. After that IBM was created new version that memory was increased to 128 MB, 256 MB.... During that time PC used operating system DOS (Disk Operating System) to operate the computer.

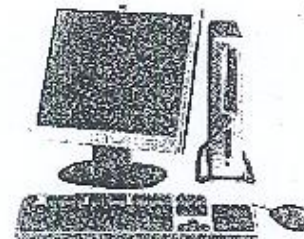
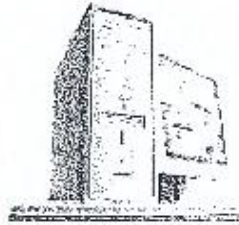
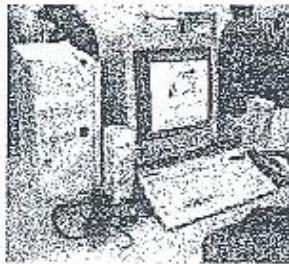

- Fifth generation (Now-Future): According to some analysis show that in up coming years the computer system will develop to the mobile computers.

## II. Computer Component

Generally computer is combining from Software and Hardware.

- Software: is the program of the computer (soft) such as: Microsoft Window XP, Microsoft Office XP, Microsoft Word, Microsoft Excel, Microsoft Publisher, Microsoft Outlook, Microsoft Access...etc.
- Hardware: Are the physical components of the computer (hard) such as Hard Disk, Monitor...etc.

## III. Computer Requirement

The computer can operate by the combination of its components such as Monitor, Keyboard, Mouse and System Unit. System Unit has its components such as Main board, Central Processing Unit (CPU), Hard Disk Drive, Floppy Disk Drive, VGA, RAM, Power Supply, and CD ROM Drive.

### A. Function and role of Computer Hardware

- 1- Monitor: It's similar to the television use as the screen to display information when we are using computer. Monitor has many sizes such as 14 ink, 15 ink, 17 inks, 19 inks and 20 inks..., etc.

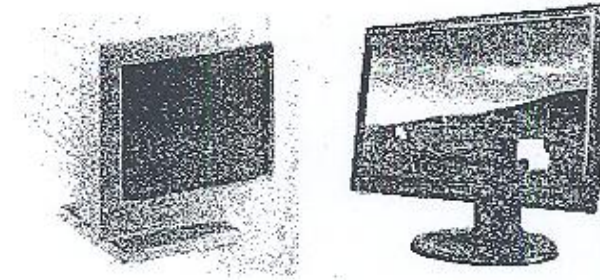

2- Keyboard: Its functions similar to typewriter but it have more functions than typewriter. Example: when we typing all the information was display on the screen of the monitor.



3- Mouse: mouse use to instead of using some keyboard; especially use to draw or drag some picture to different places. etc.



4- Case: It is the case that uses to stores all hardware computer hardware components.

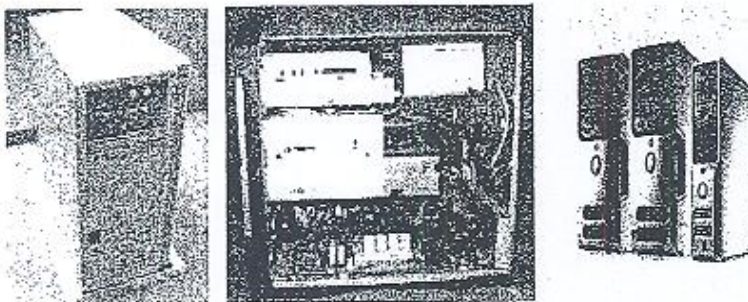

**Three New PCs  
The Power of Choice.**

Intel® or AMD processors. Build the PC that's right for you.  
Introducing the new Dimension C530, C520 and C521.



5- Power Supply: is the power use to provide the electricity to the computer.

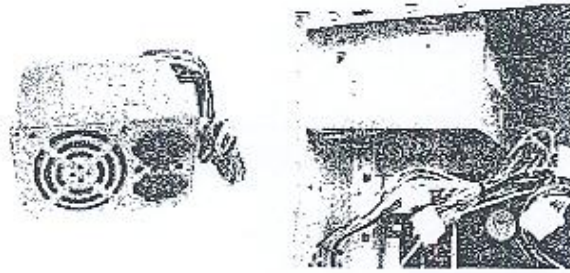

6- Central Processing Unit (CPU): is the brain of the computer that it is very important part of the computer. The first version of CPU is 8080 was produced by Intel Corporation in 1974. There are many model of CPU such as Intel Pentium, Intel Cerleron, AMD, IBM or Cyrix.

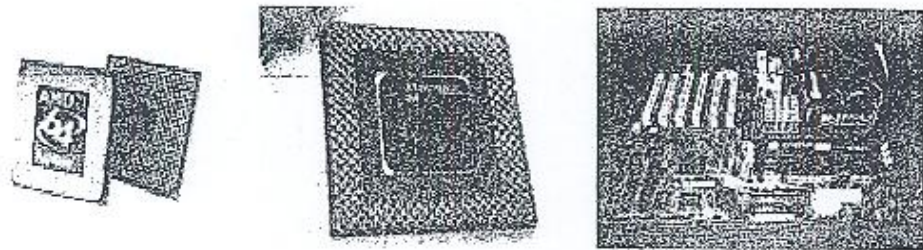

7- Hard Disk Drive (HDD): All the data of the computer was store on Hard Disk Drive, which have many size such as 20MB, 400MB, 800MB, 1.2GB, 4.0GB, 10 GB, 60GB, etc.

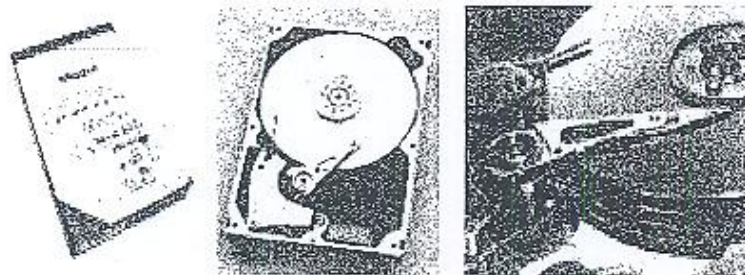

- 8- Mainboard: It is very important part that uses to command and manage all components in computer.

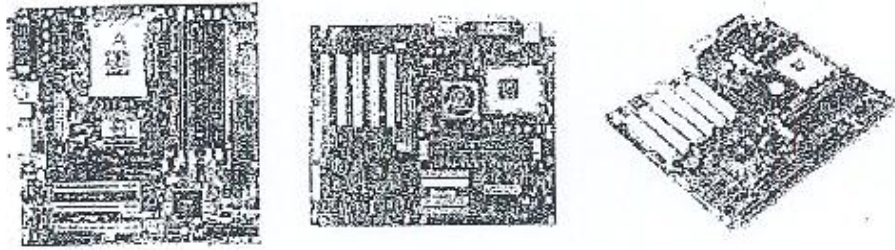

- 9- Floppy Disk Drive (FDD): is the disk drive that uses to input and out put data to the diskette.

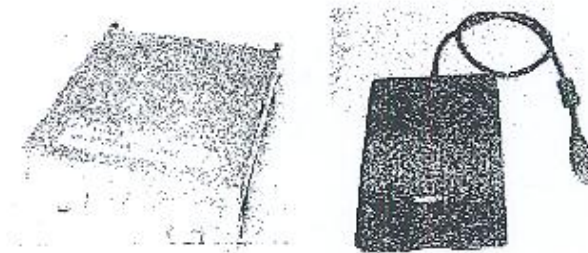

- 10- CD-ROM Drive: was used with Compact Disk (CD) to read data on CD.

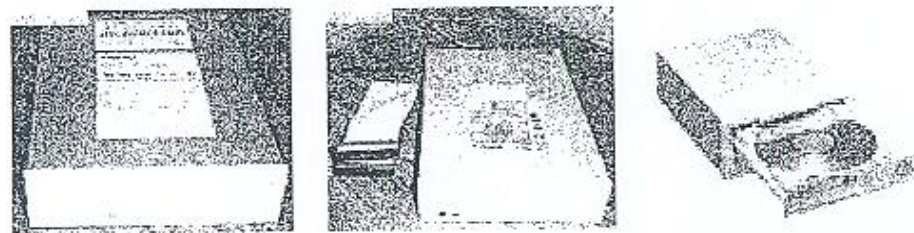

- 11- Random-Accessing Memory (RAM): is one part of computer components that use to store temporary information while the computer operating.

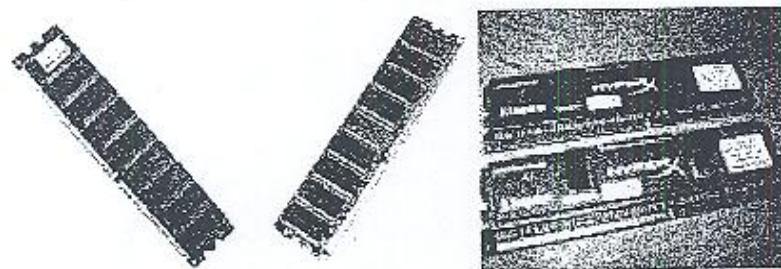



- 12- VGA Card (Video Graphic Adapter): is a part of computer components use to display information on monitor, when the VGA have big size the picture will display clear.

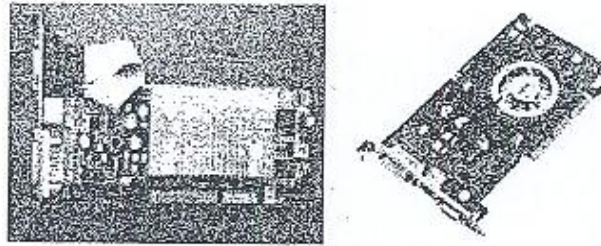

- 13- Sound Card: is use to broad cash the sound to the speaker.

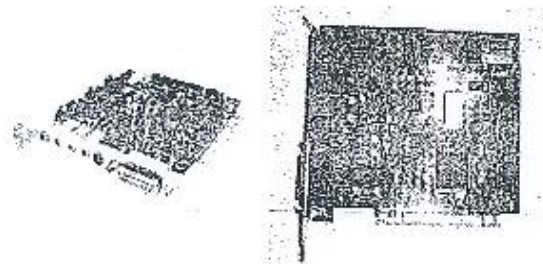

#### B. Function and role of the computer software

- 1- Microsoft Window: Is a main program which uses to manage computer processing system; without this software computer can not running.
- 2- Microsoft office: One among other programs under the management of Microsoft Window and its function is to manage administrative office work faster. This program includes Microsoft Word, Microsoft Excel, Microsoft Power Point, etc.

#### IV. How to Turn On the Computer

First, switch on the power button in front of the system case then the computer will process its Window Operating System after that the screen of windows will appear (see the following picture).

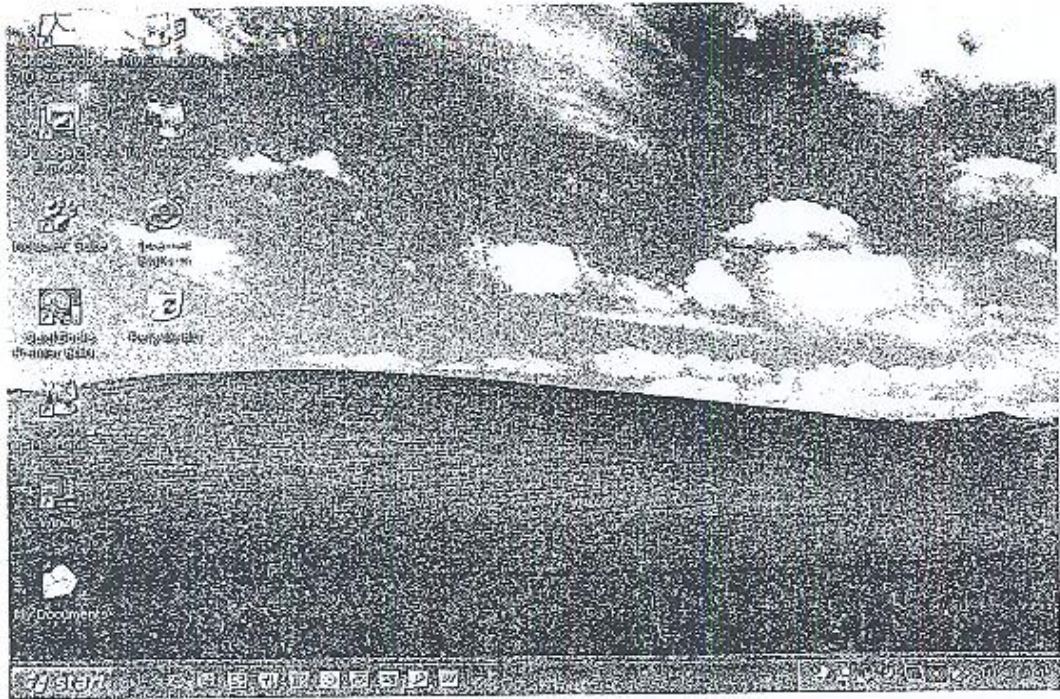

This screen was managed by Windows Operation System that has a lot of application program on it. In order to operate an application program we do the following:

- Click on Start button then
- Choose Programs then it will show the list of application program then
- Choose an application program that you want.

According to the short term of training we will only trained 2 application programs that are important to the everyday administrative work such as Microsoft Word and Microsoft Excel.

- 1- Microsoft Word: It is important to the administrative work such as Khmer typing, English typing, Creating table, etc.



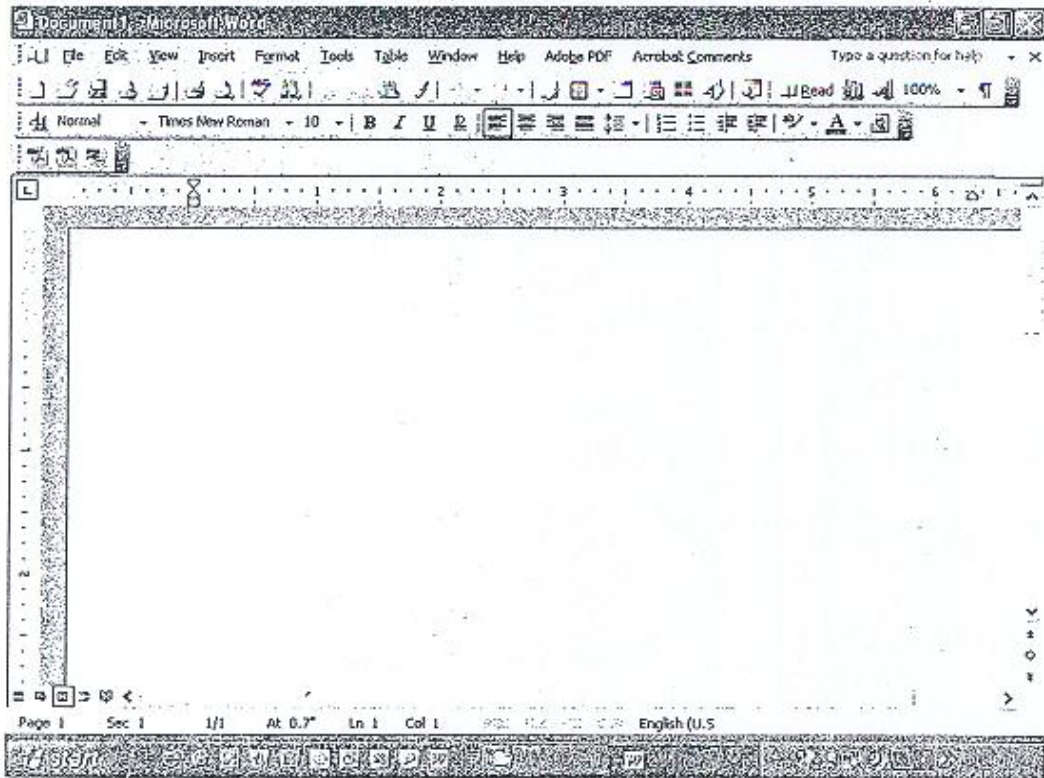

*Picture of Microsoft Word Program*

2- Microsoft Excel: It is use to do the calculation such as creating numeral table, design graphic, etc.

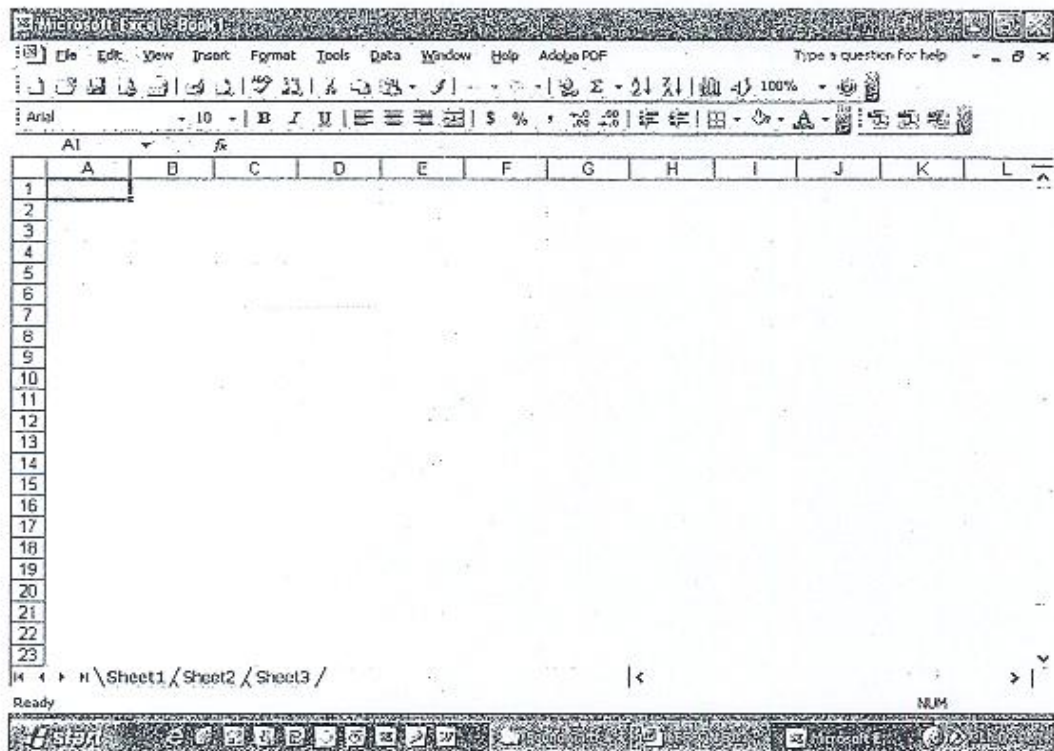

*Picture of Microsoft Excel Program*

## V. How to Turn Off Computer

- Click Start button → Shut Down or Turn Off Computer... then it will display message box that have the following buttons:
  - Shut Down or Turn Off button: It is a command use to shut down the computer.
  - Restart button: It is a command use to restart computer.
  - Stand by button: It is a command use to stand by computer when we touch mouse or keyboard the computer work as normal mode.
- Choose Shut Down or Turn Off button.



# 11-INTRODUCTION MANUAL OF MEDEM INVENTORY SOFTWARE PROGRAM

## 1) Introduction

ME Maintenance and Management is a necessary job for promoting Public Health Services as well as for reducing expenses on purchasing ME because ME maintenance can help ME work properly and can be used for long life span. Especially, ME maintenance and management can be a vital aid for Institution or Hospital Director to arrange his/ her plan properly and don't waste budget for purchasing ME and use it properly and usefully.

Therefore, as mentioning above, JICA collaborates with MoH and creates this MEDEM Project, and then creates MEDEM Inventory Software (MEDEMIS) in order to help facilitate for managing and monitoring maintenance activities.

## 2) Installing the program in computer

MEDEM Inventory Software is a program created in Microsoft Access Program and including some VB programs as well. Thus, users can use it easily by just copying MEDEM Inventory Software File (picture 1) to your computer and open it. However, as above mention, it is created in Microsoft Access Program, so MEDEMIS Program need to be installed Microsoft Access 2003 or more than 2003 first because MEDEMIS can be used only in Microsoft Access 2003.



MEDEMIS

(Picture 1)

### 3) Use

After opening "MEDEMIS", you will see one picture (picture 2) appear in your computer.

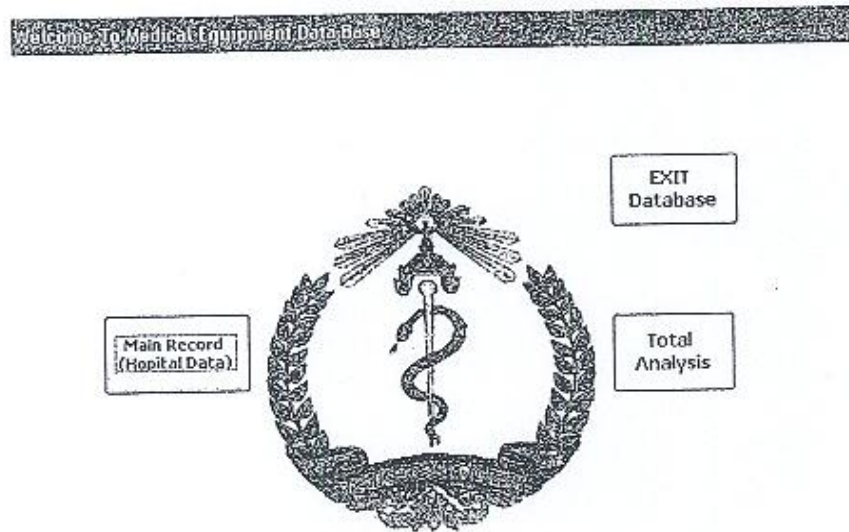

Copyright © Ministry of Health. All rights reserved, email: admin@medem@online.com.kh

(Picture 2)

- Main Record Button means that you can open to see and install related data of all ME.

### MAIN RECORD

ID_No	01001	Equipment Name	Ultrasound Scanner Black & White	Manufacture	Fukuda Denshi
Serial_No	31112316	Referent Name	Ultrasound Scanner	Agent	
Model/Type	UF-4000	Components		Operate Year	7.4
Product Date	01-Jan-00	Manual		Remain Year	2.5
Installation Date	01-Jan-01	Hospital Name	Kandal / Chey Chum Neas	Used Year	1.0
Provider	MoH	Engineering Condition	Good		
Service	Gynecology-Obstetrics	Operation Condition	Almost Daily		

HOSPITAL: Agent Name | ME Name | MANUFACTURER | Service Name

Address	Chey Chum Nas PH	Telephone	
ME Manager	Dr. Em Chea	Fax	
E-Mail		Hand Phone	011 974 884
Deputy Manager	Mr. Hem Chanthen	Deputy H/P	012 516 960
Technician Name	Mr. Chum Penha	Technician H/P	011 889 237

Find

**LIST**



Delete From Inventory

Deleted View



- Total Analysis Button means that you can see the percentage and estimated budget for repairing or purchasing equipment in the plan of the following year.

MINISTRY OF HEALTH		Close
MEDICAL EQUIPMENT MANAGEMENT		
Equipment Condition	Good %	28.51
	Fair %	33.73
	Bad %	30.12
	Unknown %	9.64
	Transfer Data To Excel	
Working Condition	Daily %	48.19
	Sometimes %	9.64
	Not Use %	32.53
	Unknown %	9.64
	Backup Refresh	
	List of Backup Condition	
Total Number of Equipment	83	
Estimation of Total Equipment Cost	\$495,000.00	

- Exit Database Button is used to close the program.
- Record Button  is the button used for commanding to see the front or back data or for installing new data. However, when installing new data and some necessary data was completed all, but the program doesn't allow you to use Exit Button or other buttons. In this case, if you want to exit, you have to click Esc Button which is located on the keyboard.
- Find Button is used to find any data of all data if you know any identity clearly of equipment such name of equipment, Serial No of equipment and Model of equipment, etc. If you want to find any information, please put Cursor on the information box and click Find Button, then type data you want to find in the Find What box after that click Find Next.
- List Button is the button used to see the table of ME in the inventory and you can choose ordinal number or type of letter in any row by just putting Cursor in that row and Right Click then click AZ or ZA whatever you like. Especially, you can also print document by just Right Click and chose  Button.
- Transfer Data To Excel Button is used to copy all ME data which exist in the program to Floppy (A:). If it is written that "Please insert Disk and try again!", it means

that you have not put Floppy Disk into your computer. Therefore, you have to click OK in order to return back and put Floppy Disk in and click Transfer Button again, you will see the written statement that "Do you want to Export Data to Excel format?" In that time, you can click Cancel to exit or OK to copy data and wait for a while, there will appear the written statement that "Export Data to Excel is finish." This means that the process of copying data to Floppy Disk is finished, and then you click OK to extract Floppy Disk from your computer.

- Backup Button is the commanding button used to record all figures shown in computer. Generally, you have to use Backup Button every six months.
- Refresh Button is the button used for clicking to express that the amount of all figures shown in the screen is correct.
- List of Backup Condition Button is used to open and see all saved figures.

#### 4) ME Data

Based on the current necessity and several times of discussion with Database Working Group which is the collaboration between members from JICA (MEDEM Project), Ministry of Health and National and Maternal Child Health Center, we decide to include some necessary data into MEDEMIS Program as below:

- "Name of Equipment" which we already study about the price already in the program by just selecting the name of any ME only.
- "ID No" is determined as abbreviation of the Institution or Hospital with two letters, one hyphen and three ordinal numbers which are the amount of ME by counting from number 001 until the last number. For example, in Phnom Penh Municipal Referral Hospital, ME must contain ID No "PP-005" or "PP-102", and each ME must not have the same ID No. Therefore, the two-letter abbreviation of each Institution or Hospital is not the same too and is determined as below.



Name of Province NH / MoH	ID	Name of Province NH / MoH	ID	Name of Province NH / MoH	ID
Prey Veng	PV	Siem Reab	SR	Kampong Cahhnang	KG
Battambang	BB	Stung Treng	ST	Kampong Cham	KC
Pursat	PS	Koh Kong	KK	Kandal / Chey Cgum Neas	CN
Monkol Borei	MB	Takeo	TK	Svay Rieng	SV
Sihanouk Ville	SN	Kampong Tom	KT	Kampot	KP
Kampong Speu	KS	Kratie	KR	Phnom Penh Municipal Hospital	PP
Prea Kossamak Hospital	KO	Preah Bat Ang Duong Hospital	AD	National Pediatric	NP
Khmer-Soviet Friendship Hospital	KH				

- "Installation Date" is the record of completed date of day, month and year which the program can accept. However, if the information contain only the year, the program cannot accept it, and it's required to find and add the day and month. For example, 15-Jan-06 or 01-Feb-06.
- "Manufacture Date" is the date which you copy from the plaque stuck on the main body of ME. This record must be in completed date: day, month and year so that the program can accept it. However, if the information has only the year, the program does not accept it, and it's required to find and add the day and month. For example, 15-Jan-06 or 01-Feb-06.
- "Manufacturer" is the name of company, enterprise or factory which manufactured this ME directly. For example, HONDA, NAKAMURA, TOITU, OLYMPUS, etc.
- Local "Agent" is the name of the company which is located in your country and imports this ME or service supplied agent of ME. For example, Europe Continents, Medicom Co.Ltd, Comin Khmere, etc.
- "Serial No" is the ordinal number of equipment made by the company and stuck on each main body of equipment. This can be said that it is the identity of equipment determined by the manufacturer.
- "Department" is the name of each department in the Institution or Hospital in which ME is located. For example, OT, Delivery, OPD, Malaria, etc.

## 12-BASIC THEORY OF ELECTRICITY

### 1- How to identify the colors of equipment (main cables)

- Selection of colors of the main cable is essential for equipment and power source.
- To connect cable of equipment with power source, first we need to select the color of equipment's cable, which one is neutral (N), which one is conductor (pH) and which one is earth line (E).

How to identify are as follows:

- + Yellow, green, or green-yellow-white cable is Earth Line (E)
- + Light brown cable is Conductor Line (pH)
- + Light blue cable is Neutral Line (N)

### 2- How to read the label on equipment

Before connecting equipment to the power source, firstly, we need to check the label stuck on the equipment to confirm which voltage is allowable for the equipment; AC 110V, 220V or 3810V. After selecting the voltage of equipment, connect the safety line (earth line) to the equipment, and then we can use it. The label indicates the following information:

Manufacturer's name.....  
Model.....  
Serial No.....  
(A) or (W).....

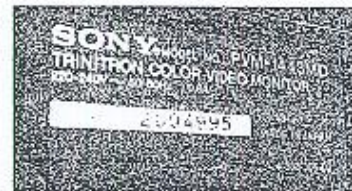

1. AC 100-220V (Can be use for AC 220V)
2. AC 115 /220V: Immediately, we can not connect with the power source, we have to select the switch to AC 110V or AC 220V depending on the power source. Therefore, we can connect with the power source.
3. AC 110V: We need to use transformer to reduce voltage (V).

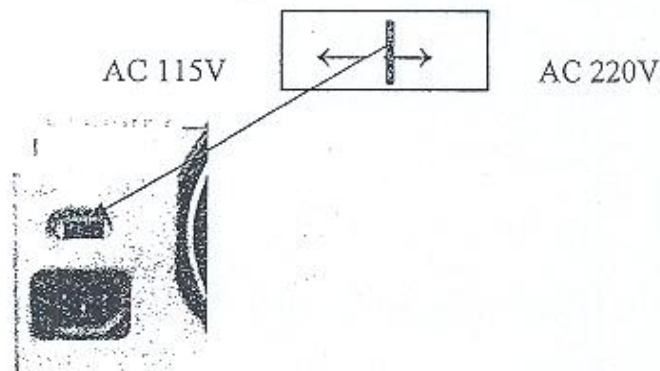



### 3- Characteristic of cross section of the electric wire

Cross section of cable (mm <sup>2</sup> )	Highest allowable current (A)		
	Each tube has 2 lines	Each tube has 3 lines	Each tube has 4 lines
1	6	6	6
1.5	10	10	10
2.5	15	15	15
4	25	25	25
6	35	35	35
10	60	55	45
25	100	90	80
35	120	110	100
50	165	150	135
70	200	185	165
95	245	225	200
120	280	259	230

### 4- Table of hazardous Level of AC and DC for Human Body

Electric current (mA)	Hazard for human body	
	50-60Hz	Direct Current
0.6-1.5	- Start feeling slightly shaking on finger	- Feel nothing
2-3	- Heavily shock on finger	- Feel nothing
5-10	- Heavily shock on palm	- Feel itching and hot
12-15	- Difficult to take out hand from the wire, hand's bone feels pain, you can endure with this situation for 10-15 seconds	- Feel hotter
20-25	- Hand's numb and can not take out from the wire, heavy hurt, contract a hand muscle, difficult to breath, you can endure with this situation about 5 seconds	- Feel hotter and shaking
60-80	- Blood circulation stops, started shaking whole body, contract a hand muscle, difficult to breath	- Feel very hot and shaking
91-100	- The blood stops circulating, if it continues for 3 seconds, heart fibrillation occurs	- Becomes asphyxia

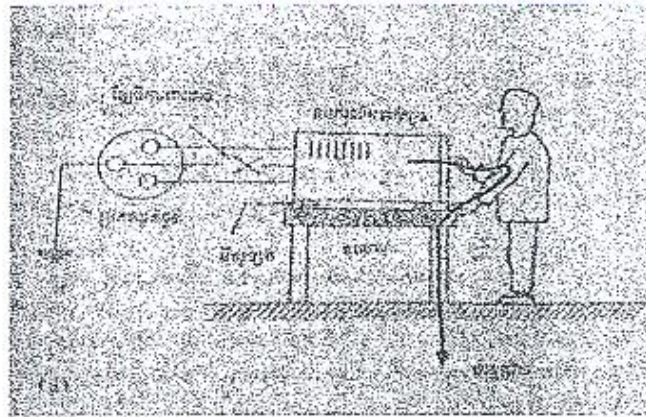

## 5- Electricity Measurement Unit

- Voltage (V), its measurement unit is Volt (V)  
1 kV = 1000V
- Current (I), its measurement unit is Ampere (A)  
1 kA = 1000A  
1 A = 1000mA  
1mA = 1000  $\mu$ A
- Power (P), its measurement unit is Watt (W)  
1 MW = 1000kW  
1 kW = 1000W
- Resistant (R), its measurement unit is Ohm ( $\Omega$ )  
1 M  $\Omega$  = 1000 k  $\Omega$   
1 k  $\Omega$  = 1000  $\Omega$

## 6- How to Operate Generator

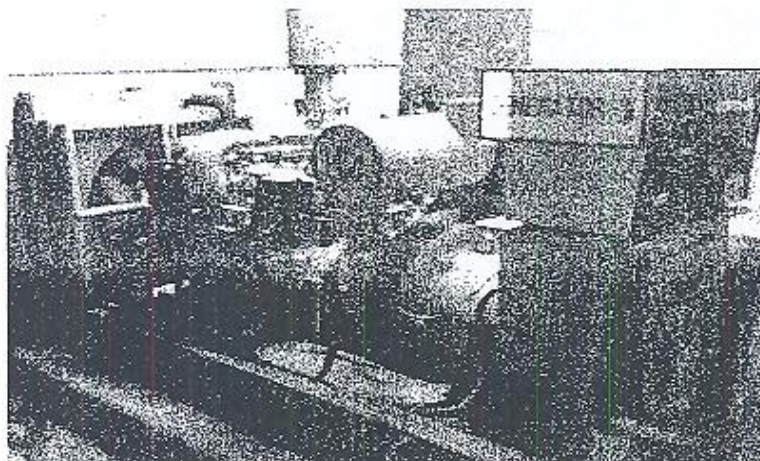



**Before starts the generator, you should carry out the following procedures:**

- Check the fuel level (if not full, refill it)
- Check the oil level, and make sure that the marker indicates between lowest and highest level. If it is not full, please refill it. Do not use different kinds or product of oil, since most of the cases, they are not fitted together. In addition, it may cause of adhesion with some parts such Piston Tissue, Cylinder Gasket, etc. Also it may cause of abnormal stain on other rotating parts.
- Test the belt with your index or thumb by pressing at the central point between both roller-wheels, and make sure that its elasticity is within 20cm-25cm.
- Check the battery for appropriate voltage or solution level. If it is not enough, please refill the distilled water into the battery layers, but not acid (H<sub>2</sub>SO<sub>4</sub>). After refill the distilled water, recharge the battery. To prevent staining on the top of the battery, apply Vaseline or grease on it. Not to use lighter or matches light source while checking solution inside of the battery as gas evaporates from inside of the battery and cause of fire.
- Check main breaker of generator whether it is in the position OFF or ON, if ON, turns it off.
- Check the control panel of the generator for broken or scratched cables.
- Start the generator to process.

When the generator starts, do not TURN On the main breaker immediately.

Please check following points:

- Check that the voltage meter indicates AC 220V or 380V.
- Check that the frequency gauge indicates 50Hz
- After everything meet the above conditions, turn ON the main breaker, and then continue to check the following points:
- Check that battery recharge gauge indicates 1.5-5 bar
- Check that water temperature gauge indicates between 90-96 °C, after generator runs for 1 or 2 hours.

***Note:***

When temperature increases up to 96-100 °C, stop the generator immediately, but turn OFF the main breaker first.

**Safety:**

Hazard does not incidentally occur, however, absence of practice of the basic and simple safety measure may cause of hazard.

These are the basic safety measures for you <what you should do and what you should not do>

1-

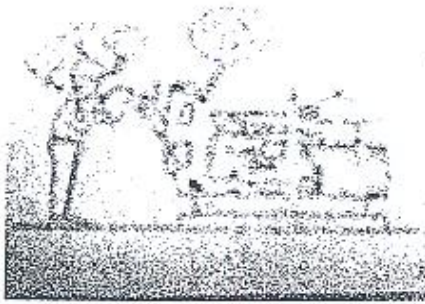

Check around the machine before starts it

2-



Check all cables inside of control panel for breaks or loose connection of cables

3-



Check around the machine again before start, and look around to confirm that no people or any other objects appear near machine

4-



Do not smokes near the battery since gas spread out from battery generates huge flame and electrolyte of battery is Sulphouric acid ( $\text{HSO}_2$ ). Clean your hand immediately if acid touched with your skin or clothe

5-



Keep the fuel far from machine. Check for any leakage of fuel.

6-



Not to touch heating parts of machine such cylinder of the machine.



7-



Do not touch any moving parts of machine while it is running.

8-



Do not open the cover of water tank immediately after turn it off.

9-



Do not do anything on the machine while it is running. If necessary inspection requires during running the machine, you must do it by two people.

10-



Connect the wire of main unit to the ground to avoid electric shock.

#### Maintenance of the generator

- Do not keep the generator running over 8 hours.
- Replace oil, not over 150 hours for the machine which the oil filter is not equipped with.
- Replace oil, not over 250 hours for the machine which the oil filter is equipped with. And replace oil filter at the same time you replace the oil.

#### 7- Calculation Technique

For example, the label stuck on the generator shows its capacity in 118 KVA, so how much is it in kW? And how much is it in A?

How to convert from kVA to kW:

Formula:

$$P = S \times \cos \phi \text{ and } P = \text{KW}$$

$$\cos \phi = 0.8 \quad ; S = 118\text{KVA}$$

$$\Rightarrow P = 118\text{KVA} \times 0.8 = 94.4\text{kW} = 94400\text{W}$$

In order to calculate intensity current of each phase (Ph), we follow the following formula:

$$P = \sqrt{3} \cdot U \cdot I \cdot \cos \varphi \Rightarrow I = \frac{P}{\sqrt{3} \cdot U \cdot \cos \varphi}$$
$$= \frac{94400W}{1,73 \cdot 380 \cdot 0,8} = \frac{94400W}{526,24} = 179,2 \text{ A}$$

If it is 1 Ph, erase  $\sqrt{3}$



Motor's Circuit monitored by switch

50 Hz 380/220 V

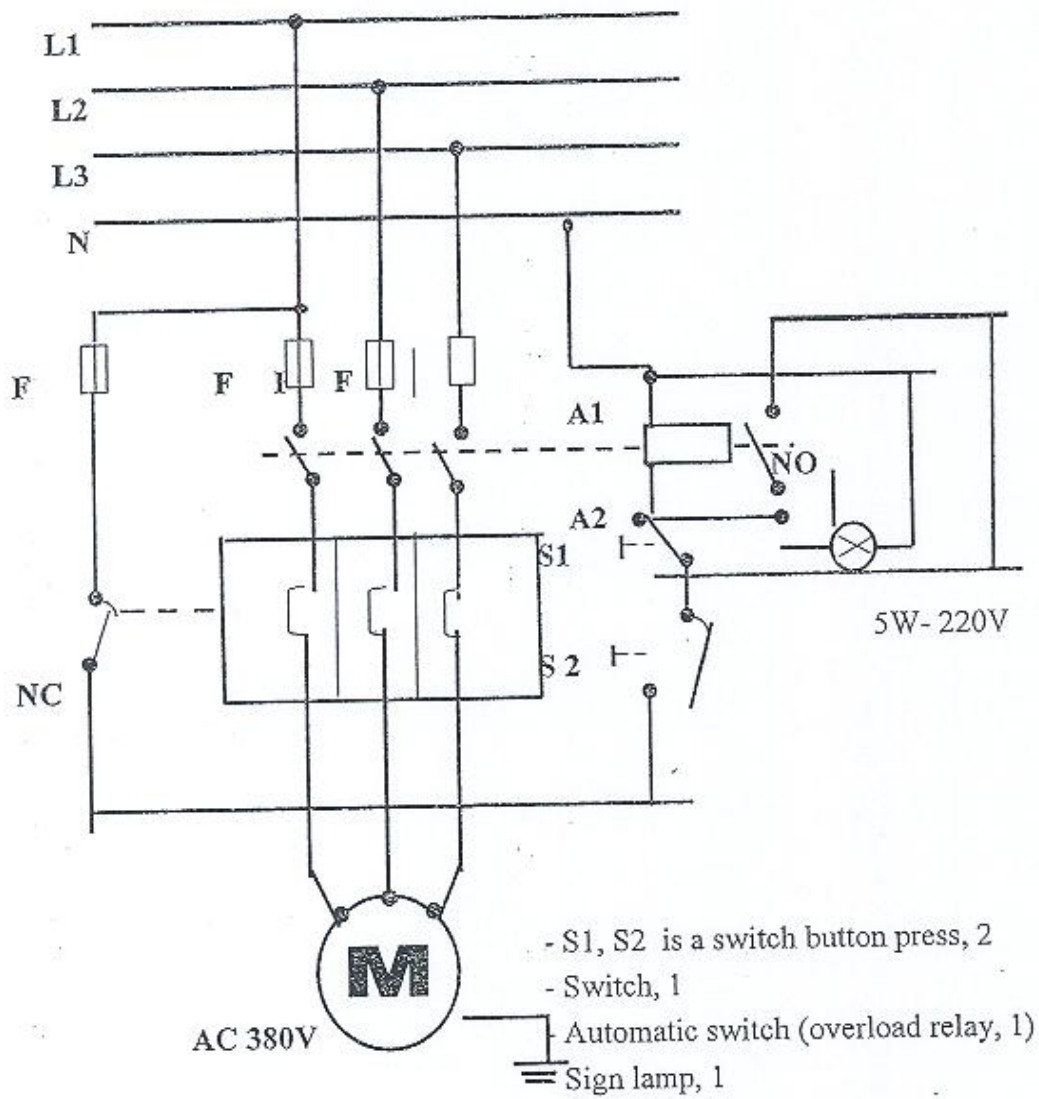

## 13-ELECTRICAL TESTING INSTRUMENTS

### I- Analogue multi- meter

#### 1. Generality of instrument

Multi-meter is used to measure the resistant (R), voltage of direct current (DCV), and voltage of alternative current (AVC). It is a kind of electromagnetic instrument, which its static component composes of a permanent magnet and moving component compose of a framed coil. With its variable circuit switch, the multi-meter can measure various ranges of AC or DC voltages and resistant.

Measuring structure:

- 1- Zero pointer adjustment screw
- 2- Range selector
- 3- measuring line inlet
- 4- Common neutral line inlet
- 5- OUT button,
- 6- 0 Adjustment knob
- 7- Pointer

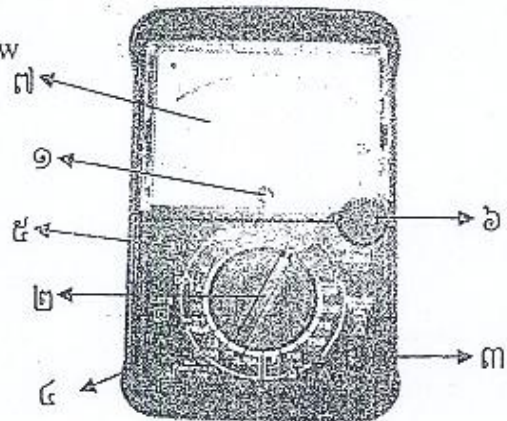

#### *Note:*

Before use, you must understand clearly on how to select the range and measuring object (electric current, voltage of AC/DC, resistant). Do not use it as long as you don't know how to measure, since mishandling might causes damage of instrument.

#### 2. How to Measure the Resistant (R)

This instrument, you can not measure the resistant (R) unless you know the circuit is cut off the power supply first.

Firstly, you need to adjust the pointer of the multi-meter to the zero position. When you put both ends of wire together, the value of resistant must equals to zero (0) and the pointer must indicate zero (0) value if the pointer does not indicate 0, adjust it to the zero position by the Zero Adjustment Knob (number 6). For this condition, since the battery in multi-meter deteriorated with passage of the time and position of the pointer might vary, you have to follow these procedures every time before you measure the resistant.

The rages of measuring resistant are as follows:

- R x 1
- R x 10
- R x 100
- R x K (K=100)



The measurement unit of resistant R is ohm ( $\Omega$ ).

In order to measure the resistant, we have to set up the Rang Selector to (Rx1), put both ends of the wire together, and then adjust the pointer to the zero position by Zero Adjustment Knob, Do not touch your hand on both ends of the wire; otherwise, the result of the measurement is not accurate, since resistant of your hand might cause of bias.

### 3. How to Measure the Voltage (U)

#### *Voltage (AC) Alternative current ( $\approx$ )*

Voltage of AC current measurement can be measured in parallel connection with power source. Before measure, you must know in advance the value of the voltage to be measured, AC 220V or 380V. If it is AC 220V, adjust the Dial to AC 250V and then measure it.

If you are not sure the value of voltage to be measured, adjust the Dial to the highest value.

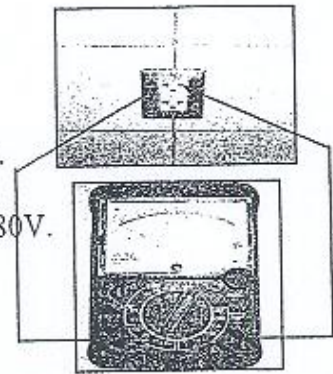

AC Dial



#### *Voltage of direct current (DC) (- - -)*

Follow the same procedures as measuring of AC voltage; you just select Dial to DC position.

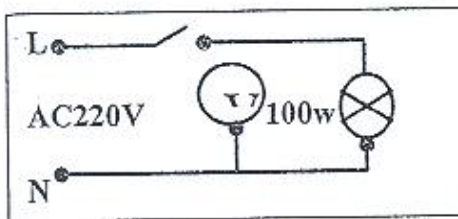

DC Dial



### 4. How to Measure the Electric Current (I)

Electric current can be measured in series connection with power source.

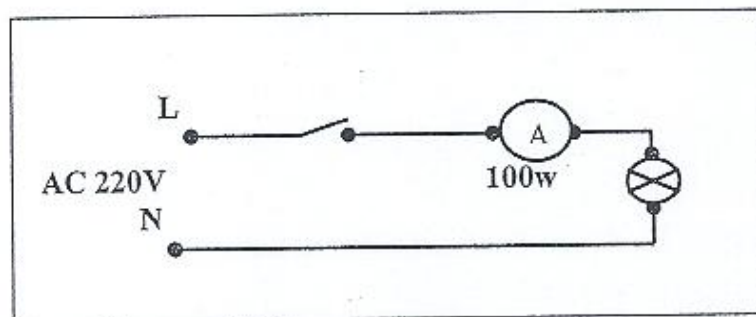

Advantage (Analog multi-meter)	Disadvantage (Analog multi-meter)
<ul style="list-style-type: none"> <li>- Cheap</li> <li>- Able to measure sensitivity of impedance</li> <li>- Easy to measure pin of transistor (B.C.E)</li> </ul>	<ul style="list-style-type: none"> <li>- Need to set up in horizontal position every time</li> <li>- Can not measure frequency (<math>H_2</math>)</li> <li>- Can not measure Ampere (A)</li> <li>- Easy broken when fall down</li> <li>- Need testing every time before use</li> <li>- Low impedance, which is difficulty to measure while circuit is under operating.</li> </ul>

## II- Digital Multi-Meter

### 1. Generality of instrument

Digital multi-meter is used to measure the resistant (R), Current (I), AC and DC voltages. Its measuring structure is as follow:

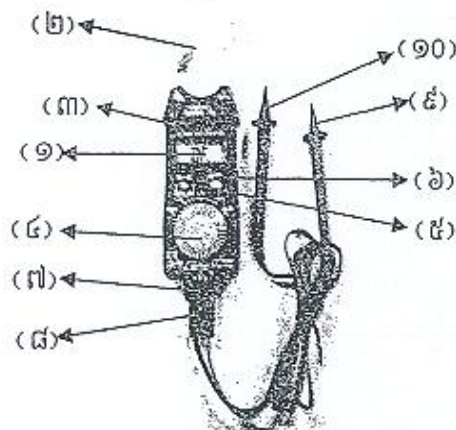

1. Screen for displaying the measuring result
2. Clamp for clamping wires
3. Clamp locker for pushing to open the clamp
4. Range selector for selecting measuring position
5. Resistant and wire measuring button
6. Display Pause Button
7. plug inlet
8. Measuring line plug
9. Red electrode for connecting to positive pole (+)
10. Black electrode for connecting to negative pole (-)



**Note:**

Before use, you must understand clearly on how to select the position of meter (number 4) to measure (I), (ACV), (DCV), (R), and carefully read the cautions below:

- When measure high resistant, wear glove and insulated shoes.
- Check the maximum voltage of the multi-meter before use it. Do not use it as long as you don't know how to measure, since wrong selection of the range might causes damage of instrument. Please read the lesson clearly at first. Switch (OFF) the multi-meter after use.

**2. How to Measure the Electric Alternative Current (I)**

- Firstly, dial the range selector (number 4) o the position of (-A)
- Push both sides of the clamp lock (number 3) to open the clamp
- Clamp only one line of power source of the equipment (Number 2)
- Switch on the equipment, then the value of the electric current (I) of the equipment display on the screen (number 1). Every time when measure the electric current (I), you don't need to use the electrodes of the multi-meter. Please see the figure below.

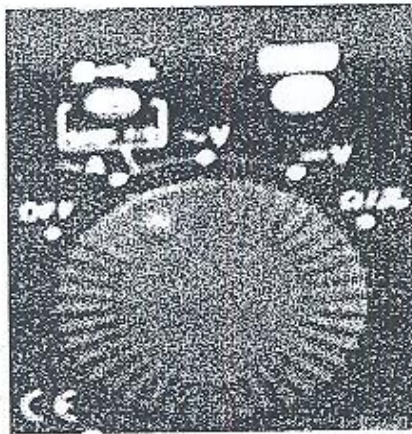

Position of range selector

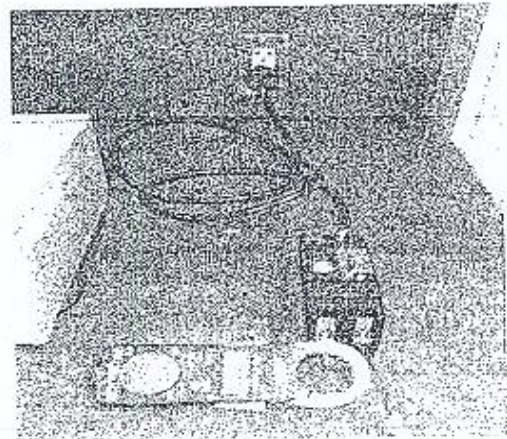

How to measure

**3. How to Measure the Voltage of Alternative Current (ACV)**

- Dial the range selector (number 4) to the position of (~V)
- Plug the wire of (number 8) into the plug inlet of (number 7)
- Connect both tips of electrode (number 9 and 10) to power source, then the result will display on the screen (number 1). Please see the figures bellow.



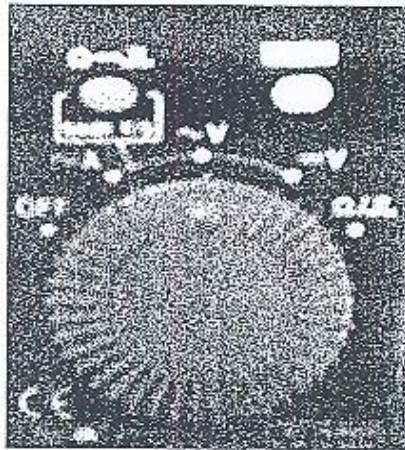

Position of range selector

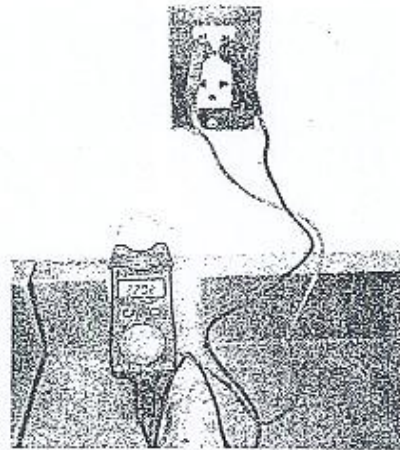

How to measure

#### 4. How to Measure the Voltage of Direct Current (DCV)

- Measuring the voltage of DC is done in same procedures as measuring of AC voltage, just change the range selector to the position of DCV(- - - V), and then connect tip of black electrode (number 10) with negative pole (-) of the battery and connect the tip of the red electrode (number 9) with positive pole (+) of the battery.

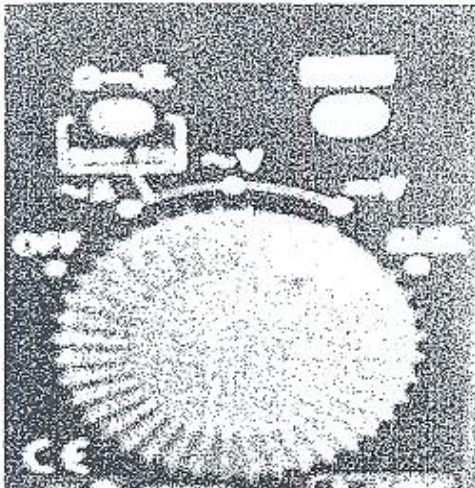

Position of range selector

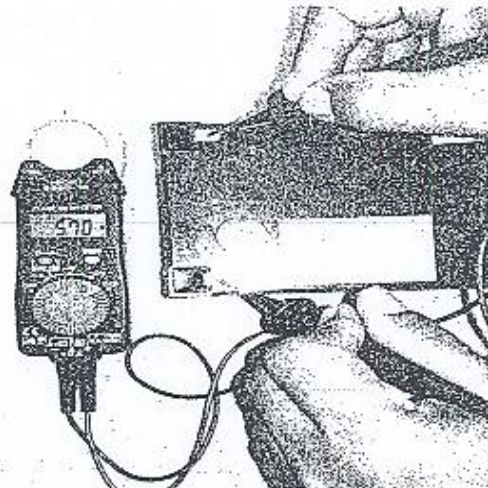

How to measure

#### 5. How to Measure the Resistant (R)

- Disconnect the equipment from the power source.
- Dial the range selector (number 4) to the position of (  $\Omega$  )
- Take plug (number 8) to plug in the inlet of (number 7)
- Push on button (number 5) to display (M $\Omega$ ) on the screen (number 1)
- Connect both tips of electrode (number 9) and (number 10) to both ends of resistant, then value of resistant will display on the screen (number 1).  
Never touch your fingers with tips of electrode, otherwise, the result of



the measurement is not accurate, since resistant of your hand might cause of bias see the figure below

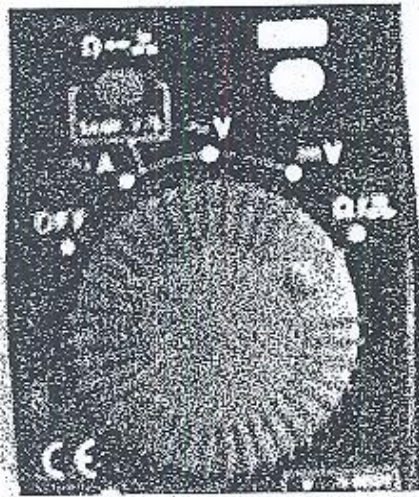

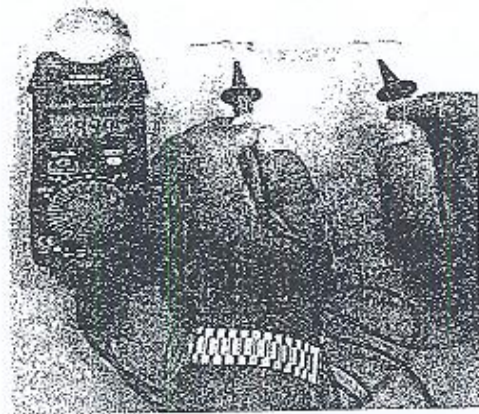

Position of range selector



How to measure

#### 6. How to Measure the Resistant (R) of Wire

- Dial the range selector (number 4) to the position of (  )
- Take plug (number 8) into inlet plug of (number 7)
- Push button (number 9) to display symbol (  ) on the screen (number 1)
- Put both tips of electrode (number 9) and (number 10) together, and then you will hear the sound from the inside of the multi-meter. This means that wires of the multi-meter is working appropriately. If no sound, it is damaged; you have to change by new wire. You need to test as mentioned above before you measure something to ensure whether wire of testing electrode of the multi-meter is working or broken down. If it is broken, you can not measure anything; you need to change new wires.

Connect the end of this meter together

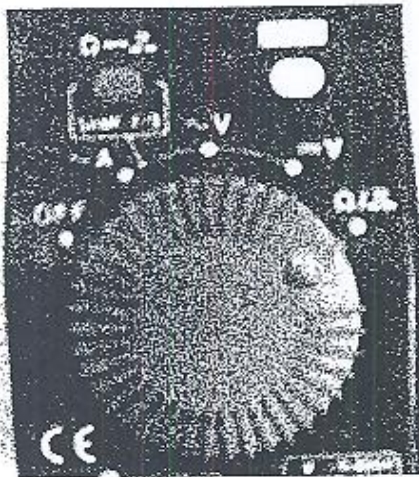

Position of range selector

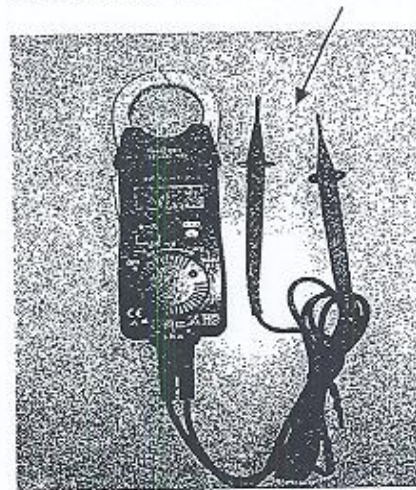

How to measure



Advantage of Digital multi-meter	Disadvantage of Digital multi-meter
<ul style="list-style-type: none"> <li>- High impedance</li> <li>- Result of measuring is perfect</li> <li>- It does not disturb range of circuit of electronic equipment while equipment is running</li> <li>- Endure the dropping down</li> <li>- Measuring result displays in number, which is easy to read</li> <li>- No need to adjust to zero position when use it</li> <li>- No need to care for vertical or horizontal position</li> </ul>	<ul style="list-style-type: none"> <li>- Expensive</li> <li>- Difficult to measure pin of transistor</li> <li>- Can not measure the transforming current of condenser</li> <li>- Show signal on the screen when the battery becomes low</li> <li>- It might be interfered when it is used near high frequency.</li> </ul>

### III- Introduction to Other Testing Instruments

#### 1. Frequency (Hz) Meter

Frequency (Hz) measurement can be measured as parallel to power supply/source by frequency meter.

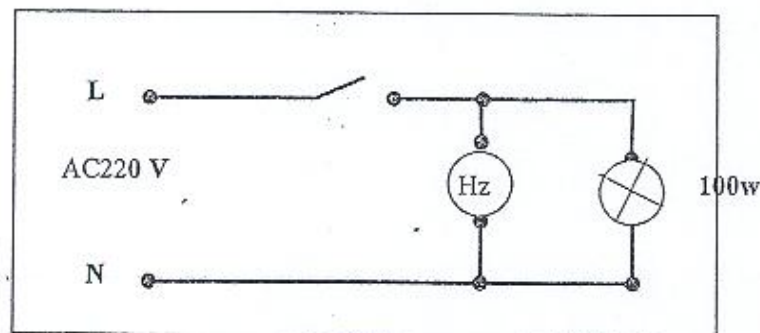

#### 2. How to use the Isolator Resistant Meter

Resistance of isolator can be measured by the isolator testing instrument at the voltage of DC under 500V between each point, and its value must not lower than 10M $\Omega$ . The measuring procedures are as follows:

1. Connect Ph pin and Neutral pin of the plug with the switch of the equipment in the condition of OFF.
2. Connect together the earth wire, Ph and neutral pin of the plug, afterward, test with the switch of the equipment in the condition of On and Off. But need to disconnect this earth cable from main body of equipment first.
3. Connect Ph pin and neutral pin of the plug together, and touch it with any conducting part of the equipment in the condition of SWITCH ON and OFF



## Isolator resistant meter wire tester instrument

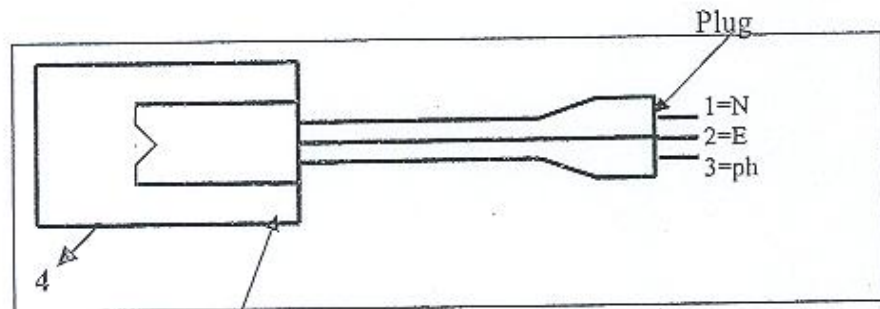
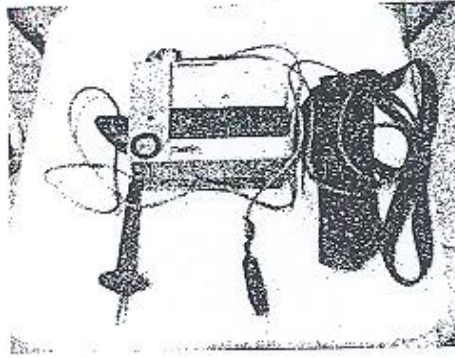

Conducting part of equipment

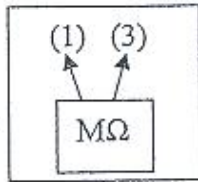

- Switch of equipment is OFF

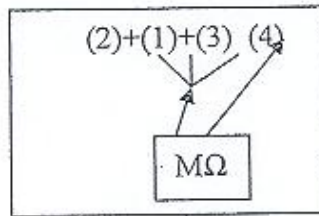

- Switch of equipment is ON /OFF

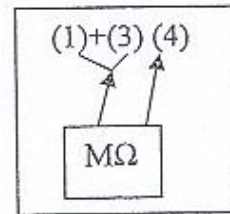

- Switch of equipment is ON/ OFF

### 3. Ground Resistant Tester

#### How to measure:

- Check battery
- Adjust the Dial to the Battery Check Position
- Press and hold on the Push On button and read the pointer of the tester, make sure that the pointer indicate the big bold point (Battery OK) and release that button.
- Move the terminal to position number 3
- Adjust Dial to position X1
- Connect with the equipment the line to be measured

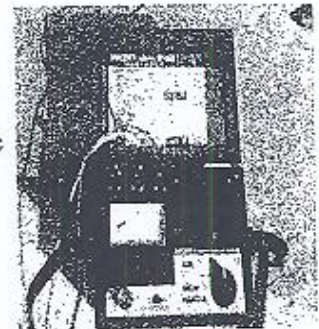

- (see the figure). Make sure the distance from one pole to another pole is between 5-10m; both of the poles 1 and 2 must be firmly planted into the ground, otherwise the value of resistant of the ground would increase.
- Connect the electrode line with pole E, P, C of the equipment
  - Begin to measure, press and hold the Push On Button and slowly adjust volume from 0-30 $\Omega$ , your eye read the pointer (A.C.V) until it reach to zero position. Stop adjusting and release your hand from the equipment.
  - As the result, resistant of the ground will indicate in the middle of red stripe at the right side of the pointer which has the value is between 0  $\Omega$ -30 $\Omega$ .

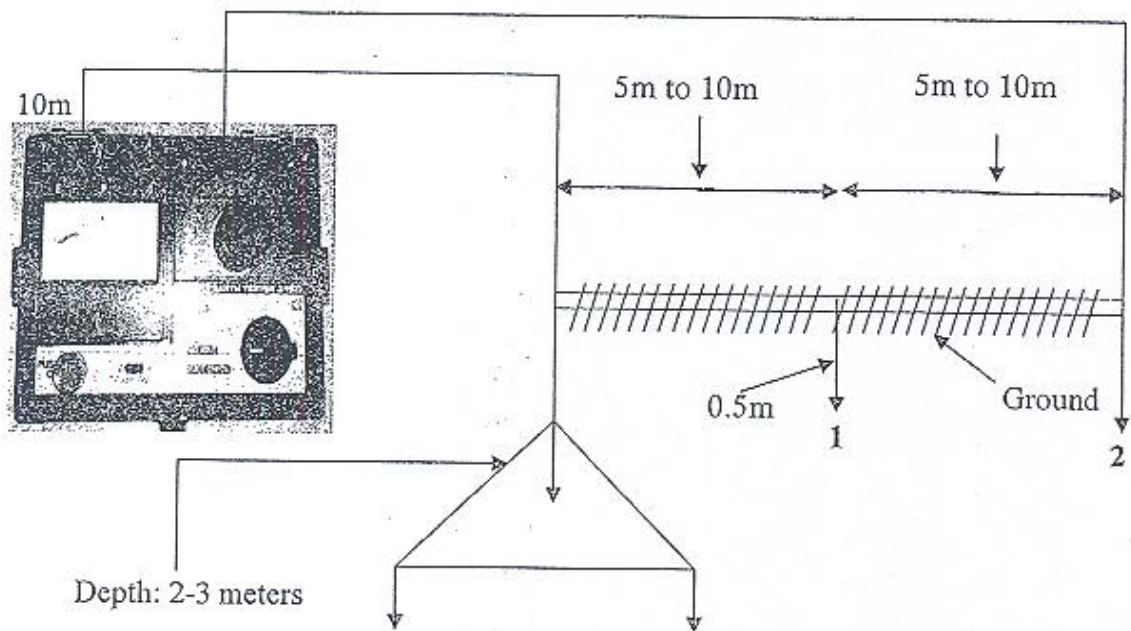



# 14-CLEANING MANAGEMENT

## 1. Introduction

"Cleaning" is the one of important activity for life. However, the importance of cleaning is often oversight. Especially in Hospital, if it is not proper cleaning activities happened, it will be occurred another problems. For example, make failure medical equipment cause by dust, and infection disease within hospital.

This manual focuses on the cleaning maintenance in hospital, and shows the way of approach.

## 2. The problem and solution regarding carrying out cleaning maintenance

If nobody involves this activity, the rooms will become more and more dirty. Not only the room become dirty, but also the life expand of machine and equipment become shorter than their actual one, and make several failure parts. If these things happens, it will bring big problem of safety and sanitary.

To archive effective cleaning activity, it is necessary to change their awareness. Especially, in hospital all staff need to have the idea that cleaning is very important activity. In the case of hospital, if hospital always keeps dirty, it might happen infection diseases, and the failure of medical equipment. If these things happened, it becomes serious problem of hospital function.

To do effective cleaning, it is necessary every staff conduct cleaning activity. It means hospital cleaning is not only activities of cleaning staff but also all staffs activities. All hospital staff needs to understand cleaning activities is necessary activity to prevent infection disease and keep safety of medical equipment. All staff has responsibilities to continue cleaning of hospital and medical equipment.

## 3. The importance of cleaning in hospital (NO dust cleaning)

Recently, it was new infection disease occurred in Asia. It often mentioned to protect such infection disease; it needs to conduct clean maintenance strictly.

And case of hospital, when focus on clean maintenance, it is necessary to consider "dust control".

In the hospital, we should consider "Dust= bacteria". Thus, we must try **no dust** cleaning in hospital.

The major causes of infection disease are bacteria and virus. And it is widely accepted that bacteria and virus is difficult to survive in clean environment; such as getting lots of sunshine, dry, cool place. However, bacteria and virus go inside of dust, they can survive long time. It means if no dust, bacteria and virus cannot survive long time, however if there are always dust in room, bacteria and virus also exist until dust is removed.

The dust is also bother for medical equipment. If filter of equipment is clogged by dust, the temperature of equipment become high, and it become one cause of failure. Moreover, bacteria, virus, bugs, and small insect come inside of filter dust; they will be grown inside of equipment. Then this equipment become nest of these things.

Moreover, dust becomes one cause of leakage. Outlet is covered with dust, then the dusts absorb water, there is high possibility to leakage and fire happened.

Overall, regular cleaning and maintenance of medial equipment and try to keep no dust is crucial activity for protect virus infection, failure of equipment and safety of hospital.

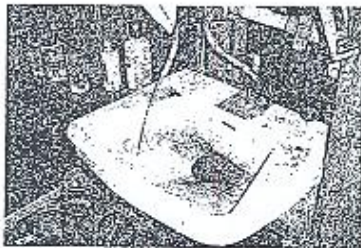

Water Sink in workshop



Dust and spider net

(Present situation of some hospital in Cambodia is like these.)

#### 4. The How to change awareness of cleaning maintenance (the success case of Japan: 5S activities)

Every one knows the importance of cleaning, however it is difficult to continue. Why to continue cleaning is difficult? The flowing is considerable reasons;

- It is thought cleaning is very minor work and look down
- It becomes dirty so that people does not want to do
- People thinks it is not their business, they think someone will do
- People does not want to spend time for this activity

The key points of changing attitude towards keeping cleanness in hospital are how to get each staff's awareness and considerations. If so, how to promote the



changing of awareness. In this section, we examine how to promote awareness of cleaning.

Recently in Japan, the activity of changing cleaning awareness is promoted especially in factory. The activity is called 5S activity. 5S focuses on organizing the workplace, keeping it clean and orderly, and maintaining the standardized conditions and discipline needed to do a good job.

The method is developed in Japan (5S stands for 5 Japanese words that start with the letter S)

- Seiri (sort): sort out what is needed and what is not needed
- Seiton (straighten): arrange essential things in order for easy access
- Seiso (scrub): keep machines and work area clean
- Seiketsu (standardize): make cleaning and checking a routine practice
- Shitsuke (sustain): make the 5S's a way of life. This requires discipline.

The key point of success is all staff involves this activity. It is necessary that everyone tackle this activity as his or her duty works. All staff decides each activity and continues as team activity. To do team play is more effective and enjoyable to bring continuous of this activity. Also it can lead create leadership by archiving this activity. These aims are important to keep activities long time.

Chart 1: System of 5S activity for sustainability

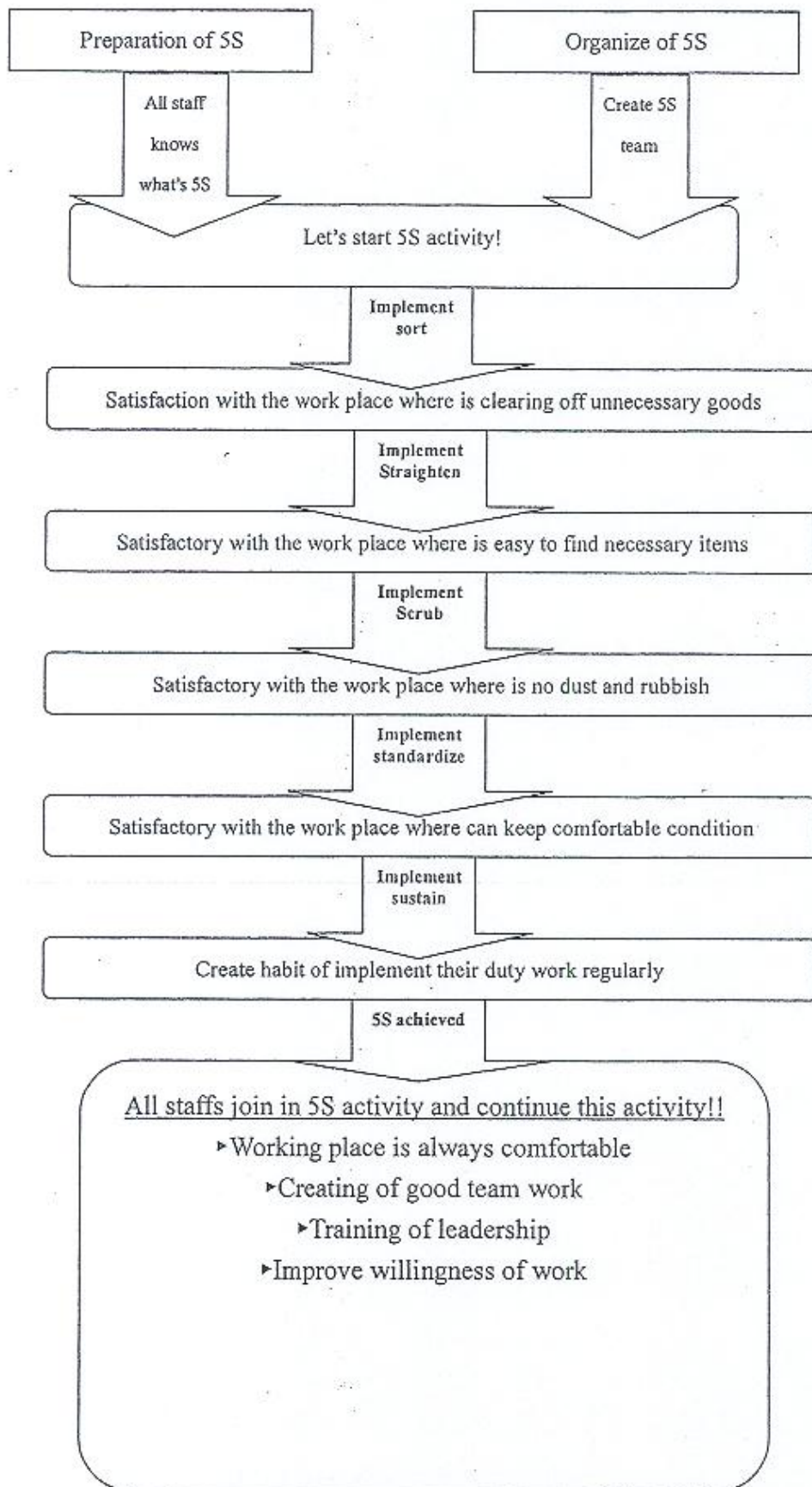



If hospital in Cambodia will implement this activity, what kinds of approaches are considerable? Table 1 is one sample of action on stage preparation and organization of 5S activity. Please refer this table and reconsider how to tackle changing awareness.

**Table 1: Sample of changing attitude towards cleaning**

- |  |
|--|
| <ol style="list-style-type: none"><li>1) Decide of leader of this activity<ul style="list-style-type: none"><li>- ME manager, technician will take these positions</li></ul></li><li>2) Create cleaning team<ul style="list-style-type: none"><li>- Involved not only cleaning staff but also user of equipment and hospital (this case including medical doctor, nurse, pharmacist etc)</li></ul></li><li>3) PR activities (slogan and advertisement)<ul style="list-style-type: none"><li>- Showing the picture of dirty room and equipment, and make them sure their hospitals are dirty</li><li>- Decide own slogan and effort to involve this activity to their duty work</li></ul></li><li>4) Structure (not individual activities but team activities)<ul style="list-style-type: none"><li>- Every staff attempt to clean their hospital because everyone make dirty (cleaning is not only one persons responsibilities)</li><li>- Use manual and check list and make easy environment to promote group-cleaning activity</li></ul></li><li>5) Evaluation activities<ul style="list-style-type: none"><li>- Give prize the place where can success 5S activity</li><li>- Use checklist to evaluate</li></ul></li></ol> |
|--|

#### Merit of this activity

It might create several merits according to implementation of 5S activities in hospital, please refer following merit and try to do 5S activity in hospital.

#### Example....

- 1) It can discover the several bad conditions in early stage to touch the equipment in 5S activity time
- 2) Even if it over look the bad condition of equipment just checking outside, when cleaning equipments it can find broken or bad parts
- 3) It can create the habit to take care their equipment and use more careful. It can extend life spans of equipment to clean of them
- 4) It become comfortable and nice office to keep clean equipments

## 5. Technique of cleaning maintenance

It explains how to cleaning in practical way.

The basic action of cleaning is:

1. Dust control (Remove dust)
2. Mopping Disinfections (Remove dirty)
3. Clean wiping (Remove bacteria)



The basic action of dust control is, “quietly, do not make dust, and do more cleanness”. And when we do cleaning, we need to be careful to avoid spreading and floating of dust. As mentioned above, dust become easy to be nest of bacteria and virus and the dust become cause of virus infection. When start cleaning, at first we have to implement to remove dust. And always need to get attention of dust control. To implement appropriate clean maintenance, it is vital to complete dust control.

Next, we need to do mopping disinfections. This is water-wiping action. The importance of this action is drained of water from mop tightly. In case of Hospital, it is important to use anti-bacteria liquid when do this action. This action will be completed to do both water moping and disinfections.

The last action is clean wiping. This action will use dry clothes. This operation is wiping the place where many people touch such as door, rail of staircase, table by dry cloth with anti-bacteria spry. To clean these parts by anti-bacteria spry, it can protect infection disease. We can make easy anti-bacteria spry by ourselves, to mix rubbing ethanol and water (proportion is 7:3). Even this simple anti-bacteria spray can get some effect. To repeat these three activities, clean maintenance is fulfillment.

To implement proper action, we need to follow some rules.

The way of cleaning maintenance has basic role. Please follow these points.





1. Up side to down side

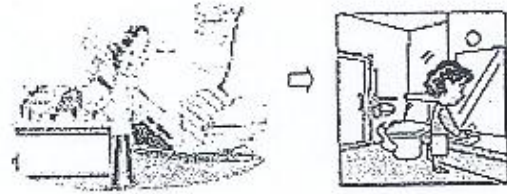

2. High cleanliness place to the other place

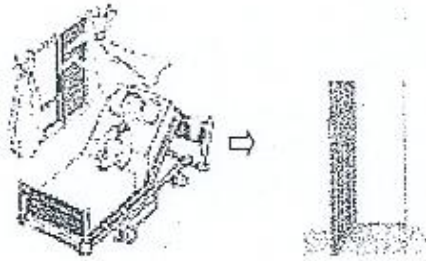

3. Back side room to front side (Door)

Understand these points, and before starting cleaning please image how to promote cleaning activities.

Please try to do no dust and comfortable hospital!!

# 15-INFECTIION CONTROL

## I. Importance of Infection Control

### 1. Introduction:

The purpose of this manual is to provide various methods to prevent infectious diseases occurred in the hospital.

Necessary instruments and measurements to achieve the important roles in preventing the nosocomial infection will be described in each chapter.

### 2. Definition:

What is Infection?

When a microorganism or virus gets into a human body, it generates many microorganisms, and then creates reaction or symptom that causes some disease.

What is Nosocomial Infection?

It is an infection occurred in the hospital or clinic. This infection might occur on patient or medical staff at 2~3 days or later, after a patient is hospitalized.

**For example:**

A patient was hospitalized for operation. After operation, wound on operation site starts generating pus. This is the infection occurs in the hospital because the patient had no this infection before operation.

### 3. Infection Agents:

#### a. Bacteria

+ Gram positive

- Staphylococcus Aureus, Streptococcus

+ Gram negative

- Ecoli, Klebsella

- Myco bacterium (Tuberculosis), etc.

#### b. Viruses:

- HIV

- H.B.V

- H.C.V, etc.

#### c. Fungi (Mycose):

- Candida Albican

- Cryptococcus, etc.

#### d. Parasites:

- Hematozoaire

- Ascaridiose



#### 4. Cycle of Infection

Microorganism spread from a person to another.

The infection might occur due to having good conditions as follows:

- 1- Microorganism
- 2- Reservoir
- 3- Place of exit
- 4- Mode of Contamination
- 5- Place of entry
- 6- Susceptible host

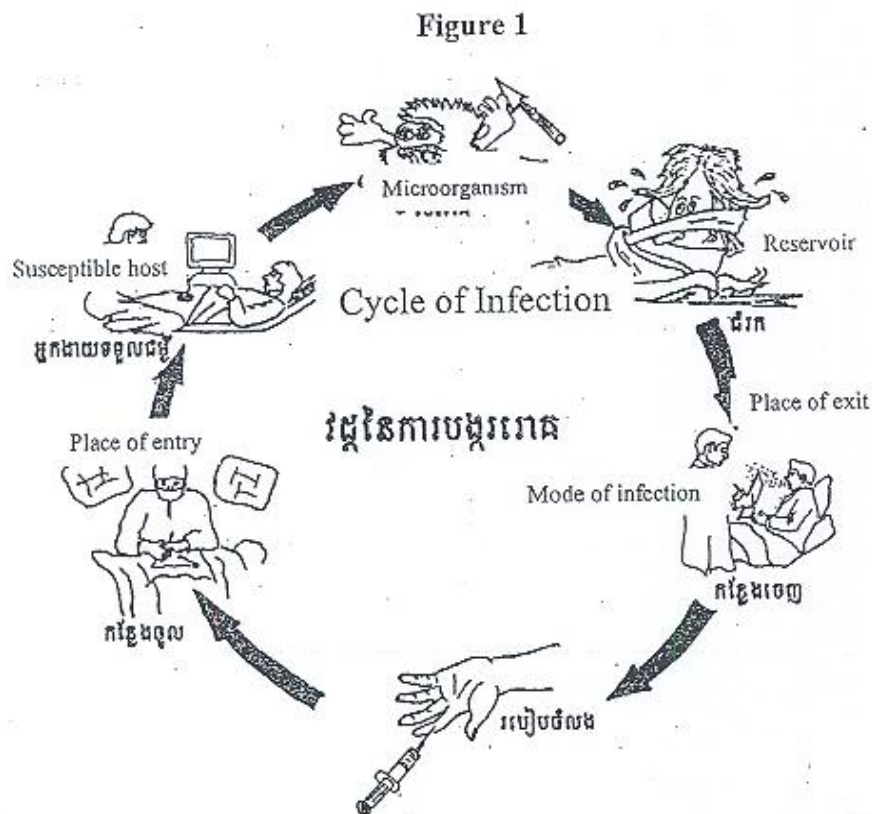

#### 5. Mode of Nosocomial Infection:

- 1- Direct contact:
  - . Hands, clothes, other contaminated materials
- 2- Air born
  - . Virus
  - . Tuberculosis
- 3- Droplet
- 4- Vector:
  - . Mosquito, fly

And, other infections that frequently occurred at the hospital, includes:

- 1- Urethral infection
- 2- Respiratory infection
- 3- Infection on operation wound
- 4- Infection via blood and body fluids

#### 6. Affects of Infection

- Increase anxiety toward patients
- Increase duration of stay and service fee
- Increase immunity with antibiotic
- Might cause patient severe and chronic illness
- Might cause patient die

#### 7. Prevention Methods

The easiest method for prevention of infection is to destroy microorganisms existing on hands, utilities, tables, shelf, beds and other materials. The effective methods for destroying microorganism are antiseptis, decontamination, cleaning, sterilization and disinfections.

The other method for prevention of contamination is using protectors:

For example, wear gloves to prevent staff from contact with blood, and appropriate disposal of waste.

## II. Infection Control for Medical Equipment Technician

### 1. Definition of Hospital Infection

The hospital infection may be classified in two types depend on that who is the secondary infected patient.

- 1) A patient who has a primary disease catches another infection at hospital.
- 2) A hospital staff catches infectious disease at hospital.

The problem of hospital infection is, ordinary people (hospital staffs) or the patients catch some indefinite disease at the hospital although those people stay at the hospital with reason. As we know, the purpose of the hospitals are an institute for providing medical care to the patient, however we must understand that hospital may be the source of the others infectious disease.

### 2. Route of Hospital Infection

The route of infection may be classified in two ways as following:

- 1) People to people directly
- 2) Medical equipment (instrument) transfer to people

The route and cycle of the infection are explained afterward. The direct infection (people to people) consists transfer by air or by contact. Medical



equipment technician (hereinafter ME technician) usually does not stay at clinical site. And there are not so many cases the ME technician contacts to the patient. However, as a staff of the hospital, ME technician needs to consider the hospital infection and its prevention. According the hospital's instructions on the hospital infection, you can refer the following chapters.

Specially ME technician should care the 2) transfer by medical equipment. ME technician should know and remind about the risk of the infection on the maintenance of medical equipment.

### **3. ME Technician and Hospital Infection**

Since ME technician is one of the hospital staff, ME technician also should follow the instruction of the prevention of hospital infection provided by hospital administration. ME technician may attend the promotion of the prevention campaign.

ME technician needs to recognize the risk of infection transferred by medical equipment or medical instruments and needs to aware the method of preventions. Achievement of the above activities protects you from the indefinite disease. As a result, others hospital staffs and the patient also will be in safety.

### **4. Risk on Medical Equipment**

ME technician sometime misunderstand or forget the risk on the medical equipment. When the medical equipment leave the patient, ME technician might handle it as a usual equipment.

Especially when the medical equipment is transferred from clinical site to maintenance workshop, ME technician have not a full realization of the dangers on the medical equipment. If the medical equipment is on the workbench of maintenance workshop, ME technician carelessly contact it same as a usual equipment such as a TV or radio. One of the reason why ME technician handle it so, because a patient doesn't appear in this situation.

Hospital is the place where patients gather and where various indefinite diseases meet on. ME technician is always contacting to the diseases not only directly but also indirectly. ME technician always needs to recall this fact.

### **5. Precaution When You Handle Medical equipment**

Particularly ME technician must take care the medical equipment, witch contaminated by wet organic materials such as blood, urine, saliva and phlegm etc. All the wet organic materials have an infective substance. For example the medical equipment, Aspirator (suction pump), Hematologic analyzer, Anesthetic apparatus and Infant incubator etc, are corresponded one. The equipment, witch installed at laboratory and operation theater, usually have a contact to the wet organic materials. And not only medical equipment but also the medical instruments are same.

When ME technician contact those equipment or instrument, ME technician need to wear personal protection item such gloves, gown and/or mask as needs



arise. ME technician need to select an appropriate personal protection item depend on the condition of the medical equipment.

Upon the condition of the medical equipment, ME technician need to apply disinfect it by washing or cleaning. And need to apply hand wash all the time after contacting the medical equipment.

A basic way of hand washing is the rubbing wash using alcohol. Instead of rubbing wash, wash with water flow using disinfect soap (solid or liquid) is recommended.

More explanations about hand wash are mentioned in after.

## **6. Collaboration for Prevention of Hospital Infection**

Essentially the hospital administration should assemble the committee of hospital infection control and the director and/or administrator need to pay attention. The committee should concern all the staff in the hospital. The committee needs to involve representative of all related department or section (administrative officer, doctor, nurse, pharmacist, laboratory staff etc.) The committee should be held periodically and invite above staffs. Discussion on the committee may provide policy, annual plan, monitoring, collection of the information and in house education.

If it is possible, ME technician may attend to this committee as a one of the supporting staff. However even ME technician doesn't attend the committee; need to pay attention on the activities of the committee.

Just in some case, even though hospital doesn't have this committee or similar function, or the committee may not work effectively, but ME technician is expected to have a role of the promotion for the prevention of the hospital infection that gained in this training.

## **III. Universal Precaution**

### **1. Definition:**

It is a common precaution or a standard to protect health staff or patients from getting infected through blood or body fluids.

Most of blood-born diseases could not be recognized without blood testing. So, it is considered that all the blood and body fluids have the possibility to have some infection such as HIV, Hepatitis B, C and so on.

Precaution is, therefore, needed for all blood and body fluids to avoid infection.

Gown technique, gloves, apron, facemask and eyes protectors, boot, are the barrier for protecting transmission of microorganism from a person to another.

### **2. When Needs to Wear Gloves?**

- When you expected that you might contact with blood or fluids.
- When take or draw blood:
- When



- ♦ Perform surgery or autopsy
- ♦ Attend delivery or examine gynecology
- ♦ Examine and take care of newborn with blood or fluid
- ♦ Treat injury

**2.1. What kind of gloves should be selected?**

- The best way is to use disposable gloves.
- The gloves that never removed from cover/ rusted/ discolored/ torn
- Thick rubber gloves have better quality than plastic gloves.

**2.2. There are many kinds of gloves; each kind has it specific features:**

A) Surgical gloves:

- Side adapts with hands
- Convenient and sensible

B) Examination gloves:

- Price is cheaper
- To be used for examination other than surgery

C) Other gloves:

- It is thick and can be used for many times
- It can be used when wash materials or dispose wastes

### How to Wear Sterile Gloves

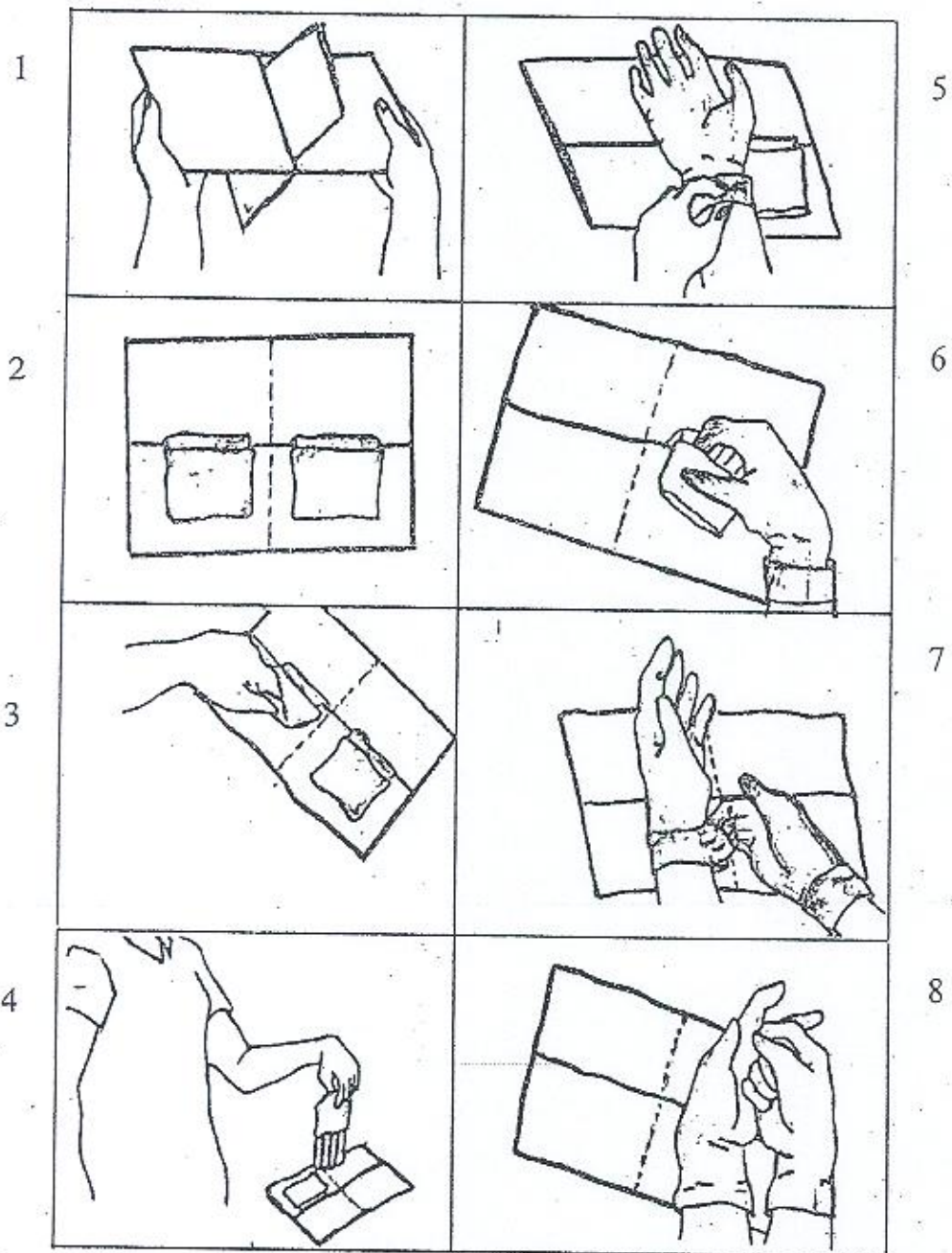



## How to Take off Gloves

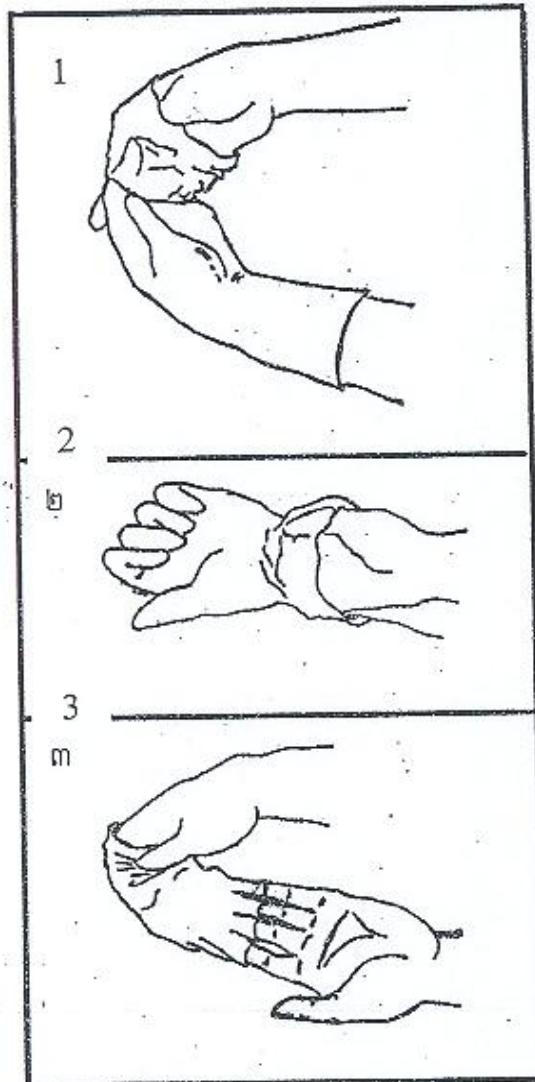

### 2.3 When Needs to Wear Facemask or Eye Protector or Boot?

- Wear it when we expected that might fall or splash blood or fluids  
*Note: We should use water-resistance/disposable mask.*
- Wearing gloves mask and eye protector is required for the personnel who perform culture in the hospital.

### 4. When We Need to Wear Apron or Gown?

- When you expected that might splash blood or fluids that might be infected.

## Procedures of Hand Washing at Ward

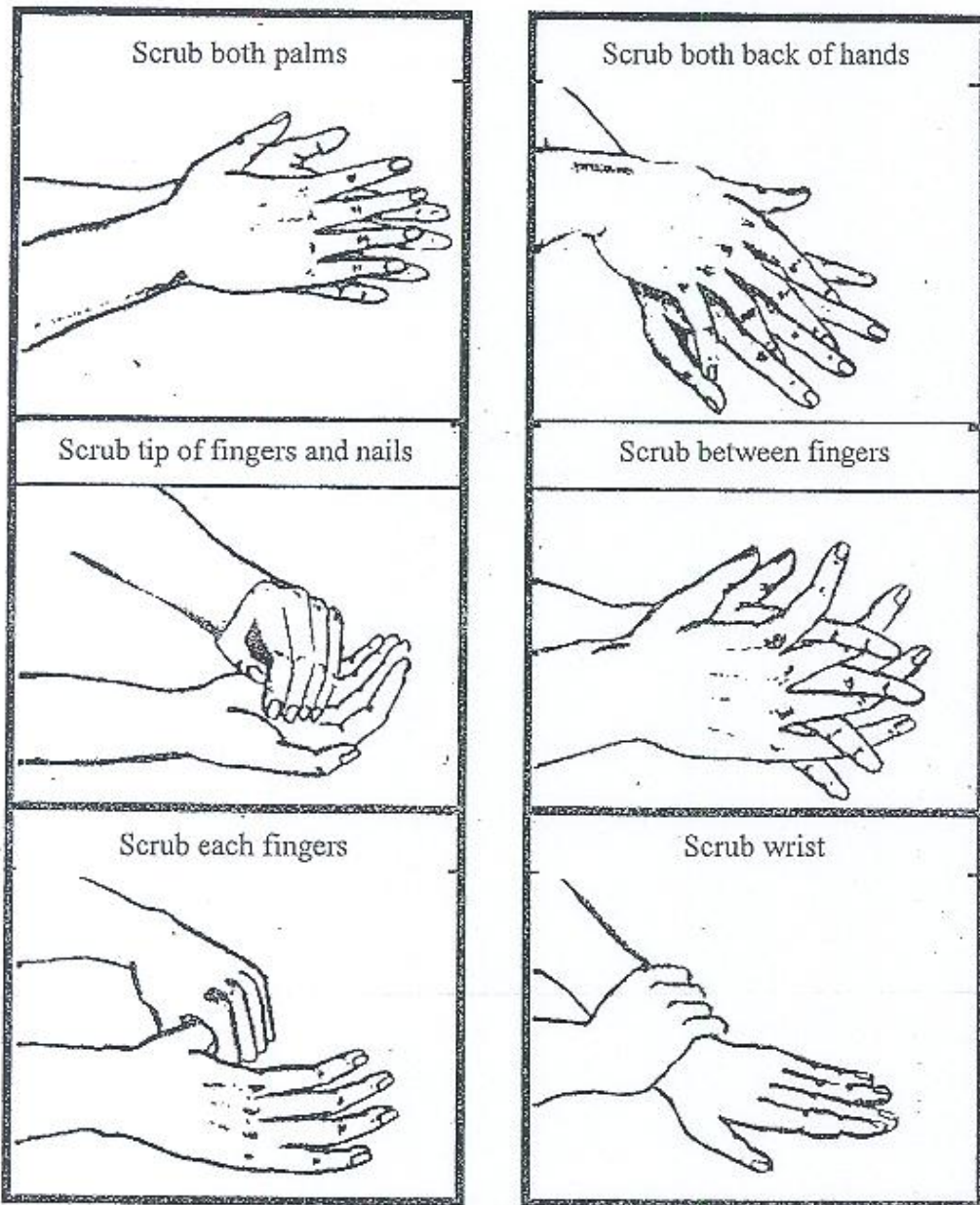



## V. Decontamination and Cleaning

### 1. Decontamination

#### Definition:

Decontamination is a process, which makes sure that materials are not contaminated after they were soaked in antiseptic solution.

#### Objectives:

To destroy microorganisms contaminated on the used materials or equipment.

#### Example:

The used materials might become a reservoir of the microorganism. Decontamination is the first step to rectify for a re-use of the surgical materials and other materials after they were used.

#### Materials to be decontaminated are:

- Syringes, needles
- Surgical instruments
- Gynecological examination materials, etc.

#### Antiseptic being commonly used for decontamination are:

- Chlorexidine 20%
- Eau de Javel 5%

#### How to perform decontamination:

It is divided into two:

#### A) Decontamination of metal materials:

##### Supplies:

- Plastic pan
- Plastic basket
- Sterile water
- Chlorexidine 20%

##### Procedures:

- Wear the gloves
- Rinse those contaminated materials first (if the hospital has Sewage Water Treatment System)
- Soak materials in solution Chlorexidine 0.5%
- Deeply soak materials in solution for 10 minutes

**How to dilute:** To get solution Chlorexidine 0.5%, dilute 25ml of chlorexidine 20% with 1L sterile water.

**B) Decontamination of plastic materials:**

**Supplies:**

- Plastic pan
- Plastic basket
- Sterile water
- Eau de Javel 5%

**Procedures:**

- Wear the gloves
- Rinse those contaminated materials before decontamination (if the hospital has Sewage Water Treatment System)
- Deeply soak materials in solution Eau de Javel 0.5% for 20 minutes

**How to dilute:** Pour 100ml Eau de javel 5% into 1,000ml sterile water.

**2. Cleaning**

**Definition:**

It is washing of dirt and microorganisms contaminated on materials after decontamination were performed.

**Objective:**

- To remove blood, oil, fates from materials. It can reduce spore of microorganism on materials

**How to Clean**

**Supplies:**

- Powder soap
- Sterile water
- Brush
- Thick gloves, dry towel

**Procedures:**

- Wear the thick gloves.
- Remove every part of material from its connection or make it opened.
- Scrub with brush with soap water at small holes between faces of the forceps.
- Wash those materials with sterile water.
- Wipe up material with dry towel.

**Table: Instrument**

	Disinfectant	Concentration	Time
Metal	20% CHLOREXIDINE GLUCONATE	0.5%: 25ml made up 5L with water	10 minutes
Non-metal Plastic, rubber	5% SODIUM HYPOCHLORITE (Eau de Javel)	0.5%: 100ml made up 900ml with water	20 minutes

**(Process)**

Using instrument → decontamination washing → (metal) sterilization  
→ (non-metal) disinfections



Decontamination and Cleaning

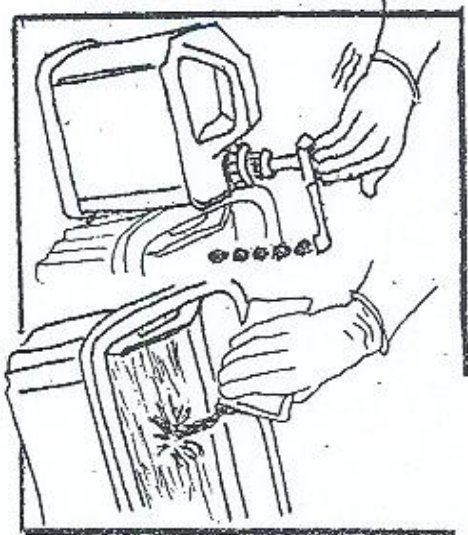

1- Dilute antiseptic solution

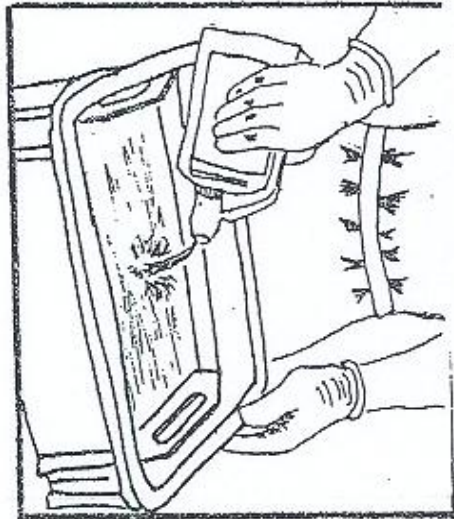

2- Decontaminate materials deeply in solution

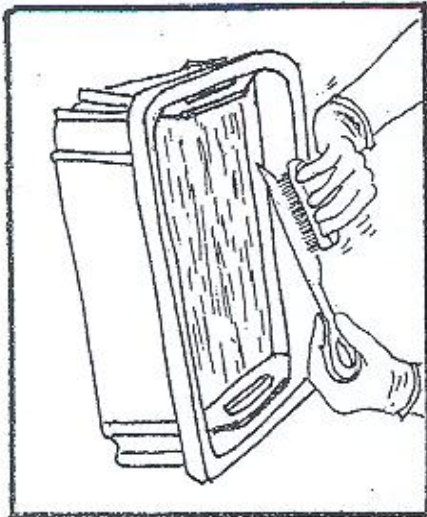
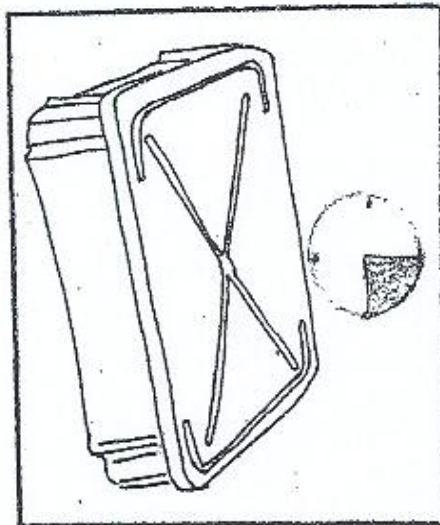

3- Cleaning

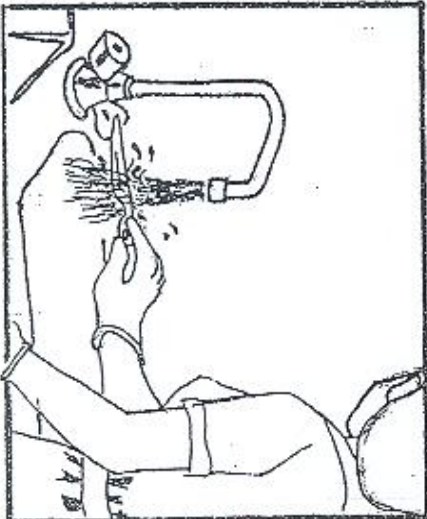

4- Wipe up materials

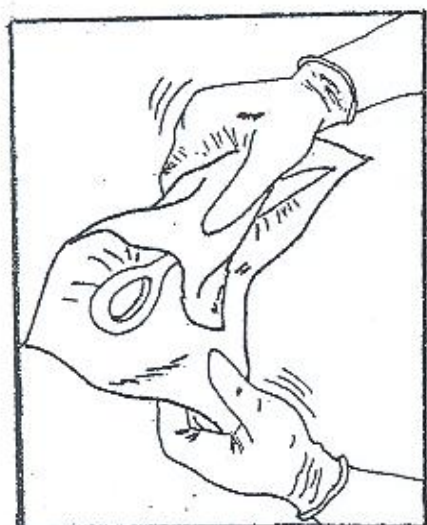

## VI. Disinfection by using Antiseptic Solution

Generally, some materials can't be disinfected with Autoclave or Etuve. To destroy microorganisms contaminated on those materials or equipments, we can use disinfection method.

### 1. Definition:

Disinfection is to destroy microorganisms contaminated on materials by using disinfectant solution.

Disinfectant: is antiseptic produced for destroy microorganisms.

For example, Cidex 2% has affective on HIV-HBV, etc.

Disinfectant solution being commonly used:

- Alcool 70-90%
- Eau de Javel 0,5%
- Chlorhexidine 0,5%
- Glutaraldehyde 2%-Cidex, etc.

### 2. How to perform disinfection:

Materials:

- Sterile water
- Plastic pan 5-10 liters
- Disinfectant
- Sterile towel

Procedures:

See the following table.



### Disinfection Procedure

Disinfectant	Effectiveness	Ho to perform disinfection	Soaking Duration	Instruction
1. Alcool 70-90%	Destroy Bacteria GR (+) and (-) TB HIV Fungi	* Soak cleaned material in alcool 70-90%	20 minutes	Before use material, leave it until dry, and don't clean it with water. Disinfection by using Alcool can keep for 1 week.
2. Eau de Javel 5%	Destroy Bacteria Syphilis Fungi TB Spore HBV/HCV and HIV	- Soak cleaned material in Eau de Javel solution 0,5% Pour 100ml Eau de javel 5% into 100ml sterile water	20 minutes	Before use material, clean it with sterile water, and then dry it with sterile towel. Eau de Javel solution 0,5% can keep 1 day.
3. Chlorhexidine gluconate 20%	Destroy Bacteria MRSA HIV Fungi HBV HCV TB Pseudomonas	Soak cleaned material in Chlorhexidine solution 0,5% How to dilute: dilute 25ml of chlorexidine 20% with 1L sterile water	10 minutes (For spore, it should soak 1 hour).	Before use material, clean it with sterile water. This solution can keep for 1 week.
4. Cidex glutaraldehyde steranios 2%	Destroy Bacteria MRSA HIV Fungi HBV HCV TB Pseudomonas	Deeply soak cleaned material in steranios solution 2%	10 minutes (For spore, it should soak 1 hour).	Before use material, clean it with sterile water, and dry it.

### 3. Boiling

Boiling is on method to destroy microorganisms on materials such as:

- Sonde intubation
- Sonde aspiration
- Speculum plastic, etc.

↳ How to boil:

Materials:

- Boiling pot
- Sterile water

Procedures:

1. Deeply soak materials in water pot. The level of water must be at least 5 cm, and taller than materials in the pot.
2. Boil materials at least 20 minutes after boiling water.
3. Boiled materials must be used it immediately or keep it in sterile box.





# Medical Equipment could be divided Three Categories:

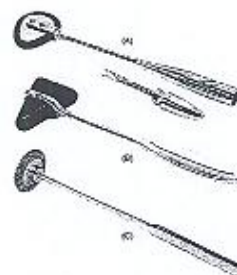
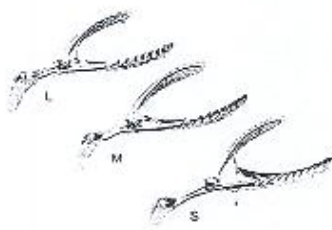

Medical Instrument

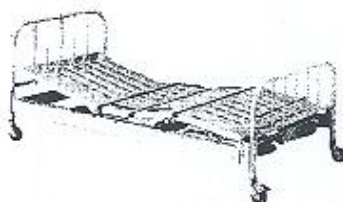

Medical Furniture

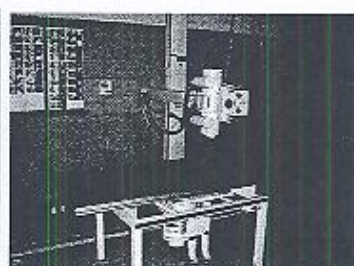

Medical Equipment